

Industrial small servo drive system

connective
dynamic
compact





**Catalogs, CAD files and instruction manuals
can be found in our download center on**

<https://cyber-motor.wittenstein.de/en-en/download/>



Contents

The Group	04
WITTENSTEIN cyber motor	06
Small servo drive system	08
Integration and performance without limits	08
Connective at all levels	10
Outstanding solutions for complex motion tasks	12
Applications in practice	14
cyber® simco® line	18
Intelligent down to the last detail	18
MotionGUI software	20
Web server	22
Servo drive for high-performance applications	24
Technical data	26
cyber® dynamic line	30
Servo motor	32
Servo actuator	34
Linear actuator	39
TPM+ dynamic / power	44
Cables	52
Accessory	62
Order codes	64
Service concept	68

GROUP



WITTENSTEIN | alpha

WITTENSTEIN alpha GmbH
High-precision servo drives and
linear systems



WITTENSTEIN alpha develops and produces mechanical and mechatronic servo drive systems for sectors that require maximum precision. Our products consistently raise the bar around the world.

We have divided our product portfolio into two areas in order to meet very different requirements: in the high-end segment, we focus on technology and performance, while in the general segment, cost-effective and high-demand products are the main focus.



WITTENSTEIN | cyber motor

WITTENSTEIN cyber motor GmbH
Highly dynamic servo motors and
drive electronics



WITTENSTEIN cyber motor develops and produces technologically advanced servo motors and demanding drive electronics as well as complete mechatronic drive systems with maximum power density. Our expertise is in specialized motors for ultra-high vacuums, high temperatures and radioactive environments.

We collaborate closely with our customers to exchange ideas, learn from each other and discover new opportunities that help our customers stand out from the competition.



WITTENSTEIN | galaxie

WITTENSTEIN galaxie GmbH
Superior gearboxes and drive systems



WITTENSTEIN galaxie develops and manufactures radically innovative gearboxes and drive systems based on a totally new functional design principle. With this unique expertise, we are the global leader in rotary mechatronic drive technologies.

These innovations help our customers designing machinery with vast performance parameters to secure their competitive core-advantages for the future. Our solutions enable products to be manufactured in a particularly efficient and resourceful way.



WITTENSTEIN motion control GmbH
Mechatronic and Cybertronic Drive
Systems for Extreme Environments



WITTENSTEIN motion control uses our own servo motors, gearboxes, electronics and software to develop and produce customized mechatronic systems for especially critical environments. Our development expertise and the high level of vertical integration of the components ensure that these technologies meet our customers' requirements.

Our innovative solutions are focused on fields where success depends on performance, robustness and reliability – aerospace, defense, simulation and subsea. Real-time safety software rounds off our portfolio.



attocube systems AG
Nanoprecision drive and measurement
technology solutions



attocube develops and produces drive and measurement technology for highly demanding nanotech applications. Their product range includes everything from piezo-based compact motors to innovative sensor solutions, which far exceed current measurement technology in their precision, speed and compactness and can also be used under extreme conditions.

Years of experience and expertise in both the scientific and industrial market segments have yielded an inspiring product catalog with maximum precision and user-friendliness. This far superior technology is revolutionizing existing applications and guarantees lasting competitive advantages for our customers.



baramundi software AG
Secure management of IT
infrastructure in offices and
production areas



baramundi provides companies and organizations worldwide with efficient, secure and cross-platform management of networked endpoints in IT and manufacturing. The Management Suite provides our customers with integrated, future-orientated unified endpoint management.

baramundi leads the way in regard to unified endpoint management in networked production environments. We develop this solution in close cooperation with the WITTENSTEIN Digitalization Center.

Comprehensive product expertise

- Rotary and linear servo motors and servo actuators
- Drive electronics
- Mechatronic drive systems

Customized solutions

- Customized solutions with maximum customer benefits
- We act holistically and are eager to explore new possibilities
- From conception and development through production and qualification to series delivery

Development and production in Germany

- Strong development team with profound competencies
- High level of vertical integration, including in-house winding room and certified test benches
- Premium quality based on innovative, controllable processes

Servo motors



Drive electronics

WITTENSTEIN – Products that know no limits

Packaging



Pharmaceuticals and Food



Assembly and Measurement Technology



Handling and Robotics



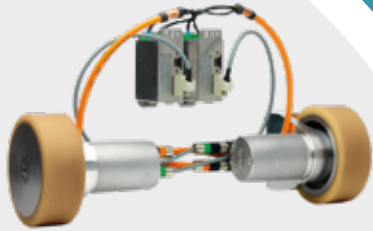

Mechatronic systems

Competent project management

- Preparation of feasibility studies for complex motion tasks
- Defined product development process supervised by certified project managers
- Certified according to DIN EN ISO 9001

From standard industry to harsh environmental conditions

- High and low temperatures
- Radioactivity
- Vacuum
- Pressure
- Explosive atmospheres
- Clean room

Testing, approval and certification

- CE
- UL
- IECEx (ATEX)
- EHEDG

Intralogistics



Semiconductor / Electronics production



Electromobility



Oil and Gas Exploration



Small servo drive system

Integration and performance without limits

cyber® simco® line



cyber® dynamic line



TPM+



cyber® iTAS® system

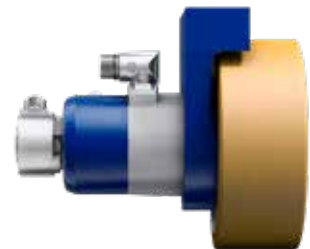

Thanks to the numerous interfaces, the small servo drive system offers maximum flexibility for the most demanding tasks in modular machine construction.

simple motion control

The industrial small servo drive system allows the simple and future-proof implementation of high-performance applications.

The servo drive of the cyber® simco® line are compatible with sine-commutated servo motors and can be integrated virtually anywhere.

Thanks to its numerous interfaces, it offers maximum flexibility for the most demanding tasks in modular machine construction and is extendable with the relevant software at any time.

Furthermore, the smart servo drive series together with WITTENSTEIN servo motors and servo actuators form a complete drive system, the intelligence of which adapts to the customer requirements and not vice versa. Connective, dynamic, compact.

connective

Flexible interfaces, intelligent software and technology functions and connection options to a wide range of control systems make the small drive system a multitalent in process design.

dynamic

Mass inertia-optimized motors, a high current resolution and coordinated control parameters permit high-precision and dynamic control of the system.

compact

Miniaturization is an integral part in the product and development strategy of WITTENSTEIN cyber motor. Servo motors with high torque density, a diameter of 17 mm and the option of decentralized use of the electronics for space savings in the switch cabinet are just a few aspects of the system.

Small servo drive system

Connective at all levels

With its flexible fieldbus interfaces CANopen, EtherCAT, PROFINET RT/IRT, EtherNet/IP, TCP / IP and RS232, the cyber® simco® line servo drive is open for connection to a wide range of control systems.

Because no additional bus converters are required, installation space and weight can be effectively saved in the machine design. The parametrization of n-axes via the TCP/IP interface also results in time and cost savings. For this purpose, the individual cyber® simco® line components must not be additionally connected to a PC, for example. Connection of the servo drive to PROFINET via the PROFIdrive drive profile with application class 1, 3 or 4 ensures particularly simple and fast commissioning. High transfer rates are achieved through the real-time

protocols – the productivity of the machine can thus be measurably increased. Moreover, the low deviation of max. 1 µs in the bus cycle (with PROFINET IRT) provides for high precision in the overall system.

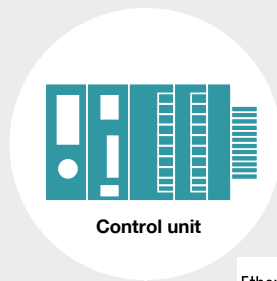

SIM 2002/2010
with protection
class IP65



SIM2010
with protection
class IP65



SIM 2002/2010
with protection
class IP20



SIM2010
with protection
class IP20



SIM2015
with protection
class IP20



SIM2050
with protection
class IP20



cyber® dynamic line



TPM*



cyber® dynamic line



TPM*

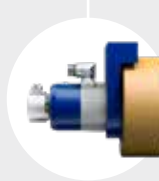



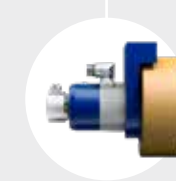



cyber® iTAS® system



cyber® iTAS® system

High transfer rates through real-time protocols measurably increase the productivity of the machine.

Interface performance	
	<ul style="list-style-type: none"> - Integration of the drive with CANopen according to protocol standard DS402 - Implementation of numerous operating modes, e.g. profile position, profile velocity, etc. - Maximum flexibility in process design through dynamic PDO mapping: Process data can be changed via dynamic PDO mapping even during operating time
	<ul style="list-style-type: none"> - Fieldbus interface EtherCAT (CoE) for connection of the drive to a Beckhoff control system – the parameters used are thus equivalent to the CANopen standard - Time saving and easy to use thanks to File over EtherCAT: Loading of files via EtherCAT bus from the control system directly to the servo drive. Data can be simultaneously distributed to any number of drives in the network, e.g. no additional wiring during firmware updates, use of existing expertise
	<ul style="list-style-type: none"> - PROFINET RT/IRT interface supports application classes 1, 3, 4 - Simplest integration in the SIEMENS software (TIA portal/ SIMOTION Scout) via the PROFIdrive drive profile - Utilization of all standard technology functions from SIEMENS - Simplest configuration through provided GSDML file – simplified axis configuration - Deviation of max. 1 µs in the bus cycle with PROFINET IRT
	<ul style="list-style-type: none"> - Industrial drive system for connection to the Rockwell control system - Implementation of different applications with cycle times of up to 5 ms - Simple commissioning and full utilization of the Rockwell control system save time and costs - no additional expertise required - Pre-prepared add-on instructions for implementation of different applications - Opmode selection: freely designable connection (parameters can be self-determined)
	<ul style="list-style-type: none"> - Synchronous motion profiles with a low cycle duration and jitter can be realized using the FSP Drive profile. - The standard function blocks and technology functions of individual PLCs can be used, so that it is a simple matter to connect and configure the servo drives.
	<ul style="list-style-type: none"> - Parametrization of n-axes via the TCP/IP interface (without connecting each individual cyber® simco® line to a PC) - Elimination of wiring requirement - Implementation of web server applications

Small servo drive system

Excellent solutions for complex motion tasks

Filling

Precise filling with servo motor-controlled filling valves through flexible control of the filling volume.



Precise.
Cost-effective.
Flexible.

Positioning

Highly dynamic and precise positioning of sensitive components.



Adjustment

High-precision and dynamic servo motors for an automated and process-monitored format or valve adjustment.



Bonding and Dispensing

Brushless servo motors with the highest reliability for challenging and precise bonding and dispensing systems.



Gripping

Servo electric grippers with high power density and minimal weight for sophisticated pick & place applications.



Measuring and Testing

Low-noise and reliable drives for innovative measurement and testing solutions to set industrial standards.



Applications in practice

Highest precision even with demanding materials



"The market places ever higher demands on dispensing and repeat accuracy."

Markus Rieger, Sales Director Germany

Customer:

bdtronic GmbH from Weikersheim

Industry:

Plant systems and process solutions for dispensing technology and other special applications

Application:

For the processing of reactive casting resins, a small servo drive system with special performance focuses was being sought: The requirement was for a complete drive solution guaranteeing the highest dispensing and repeat accuracy with completely different material properties during processing.

Solution:

The performance package consisting of cyber® simco® line drive and cyber® dynamic actuator R can reliably cope with the extremely heterogeneous influencing factors.

Description:

The complete solution from WITTENSTEIN optimally exploits the performance potential of the drive solution: The cyber® dynamic line size 40 servo motors work with integrated planetary gearheads and drive the eccentric screw pumps so that even the tiniest quantities in the microliter range can be dispensed with precision. Precise control via the cyber® simco® line servo drive makes it possible to individually regulate the dispensing quantities and to minimize the quantity tolerances. In this way, the dispensing results can be optimized in a reproducible manner – under full process control, at all times.

Special feature:

The cyber® simco® line servo drive is characterized by very high-resolution current regulation and fast current measurement. This enables the delivery of the tiniest quantities with great accuracy, even in the case of variable movement speeds.

Decentralized control.
Fast current measurement.
Innovative solutions.

Optimal system solution with decentralized control unit

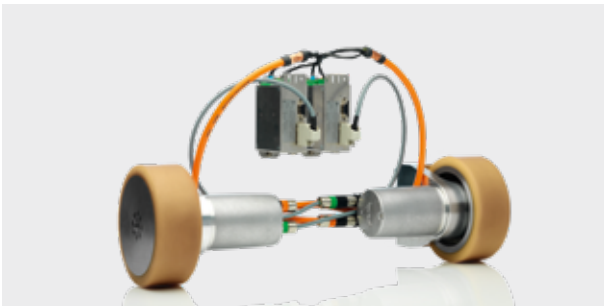

"The consulting from a single source ensures reliable project planning."

Joachim Walter, Managing Director at BeeWaTec AG

Customer:

BeeWaTec AG from Pfullingen near Reutlingen

Industry:

Mini AGV for production and warehouse logistics

Application:

The manufacturer of automated guided vehicles was looking for a tailor-made drive solution for use in a modular mini-vehicle for transporting stacked goods containers.

Solution:

iTAS[®] system with TAS 004 plus cyber[®] simco[®] line IP20 and, as a "perfect match", cyber[®] dynamic actuator R size 40 with cyber[®] simco[®] line IP20.

Description:

Through individual selection of the motor/gearhead unit in conjunction with the appropriate cyber[®] simco[®] line electronics, extremely diverse performance ranges can be covered. At BeeWaTec, the cyber[®] simco[®] line is also used as a decentralized control unit for the handling equipment on the vehicles and is adapted to the small high-torque drives of the cyber[®] dynamic line. Procuring both drive solutions from a single source was a decisive argument for BeeWaTec.

Special feature:

A special requirement for the BeeWaTec Mini vehicle is transporting overall weights of up to 150 kg, which not only have to be pulled, but also clamped to the vehicle. This is made possible by the innovative solution for the clamping actuator in the vehicle: the clamping is controlled decentrally via the cyber[®] simco[®] line. Digital inputs and outputs connect this to the vehicle computer; there is no need for a complicated fieldbus interface. BeeWaTec created a motion task for the clamping. This is part of the intuitive MotionGUI user interface and is stored in the cyber[®] simco[®] line. The motion task contains all the necessary parameters for the clamping in the form of a list.

Applications in practice

Lightweight, flexible, cost-effective – latest generation gripper technology



"Differently to e.g. pneumatic systems, the servo technology enables different linear positions to be moved to in a flexible way without any mechanical conversion operations. That was decisive for the process."

Michael Schneiderbauer, Product Development

Customer:

FILL, Gurten, Austria

Industry:

Machine and plant construction

Application:

The gripper array from the Austrian machine and plant manufacturer FILL is an innovative handling system for the automated production of CFRP and GFRP parts. Three objectives had to be met in terms of production technology process innovation in any case: maximum flexibility during gripping, significant weight reductions of the end effector and cost efficiency during procurement and operation of the handling system. The layer build-up and curing of the CFRP or GFRP parts needed to be achieved on a single mould. For this purpose, the gripper system has to be able to pick up composite lengths of different sizes and PU cores, partly preform these and set them down.

Solution:

FILL implements more than a dozen industrial small, size-32 servo motors from the cyber® dynamic line, each with a cyber® simco® line servo drive in protection class IP20, in the new handling unit. Decisive for the selection of the small servo drive systems were the compact dimensions and low weight of the motors as well as the option of integrating the servo drive in the PROFINET fieldbus environment of the handling system.



Compact design.
Low weight.
Easy integration.



Description:

Through the use of carbon tubing for the supporting structure and the small servo motors from WITTENSTEIN, a weight reduction of more than 50% and significant energy savings were achieved.

As a complete mechatronic solution, the cyber® simco® line servo drive with fieldbus integration capability and PROFINET interface was selected owing to the existing Siemens control system.

For this purpose FILL combined this with the small cyber® dynamic line series servo motor. These lightweight and compact servo motors blend in well visually and enable extremely precise movement sequences, which are determined flexibly and independently from one another and can be adapted.

Special feature:

Motor and drive from a single source – this was clearly the best technological solution for FILL because interface risks are ruled out from the outset thanks to the matched system components. For the machine manufacturer, but also for the integrators and end users, the simple connection of the existing Siemens control system with PROFINET offers numerous benefits: operation and commissioning is particularly simple and intuitive with the appropriate MotionGUI operating software. Diagnoses, optimizations and parametrization of the drive can be performed via a number of functions. Diagnostic routines and event logging are implemented by means of a real-time clock. This allows both condition monitoring and any maintenance work to be performed easily and in a time-saving manner.

cyber[®] simco[®] line

Intelligent down to the last detail

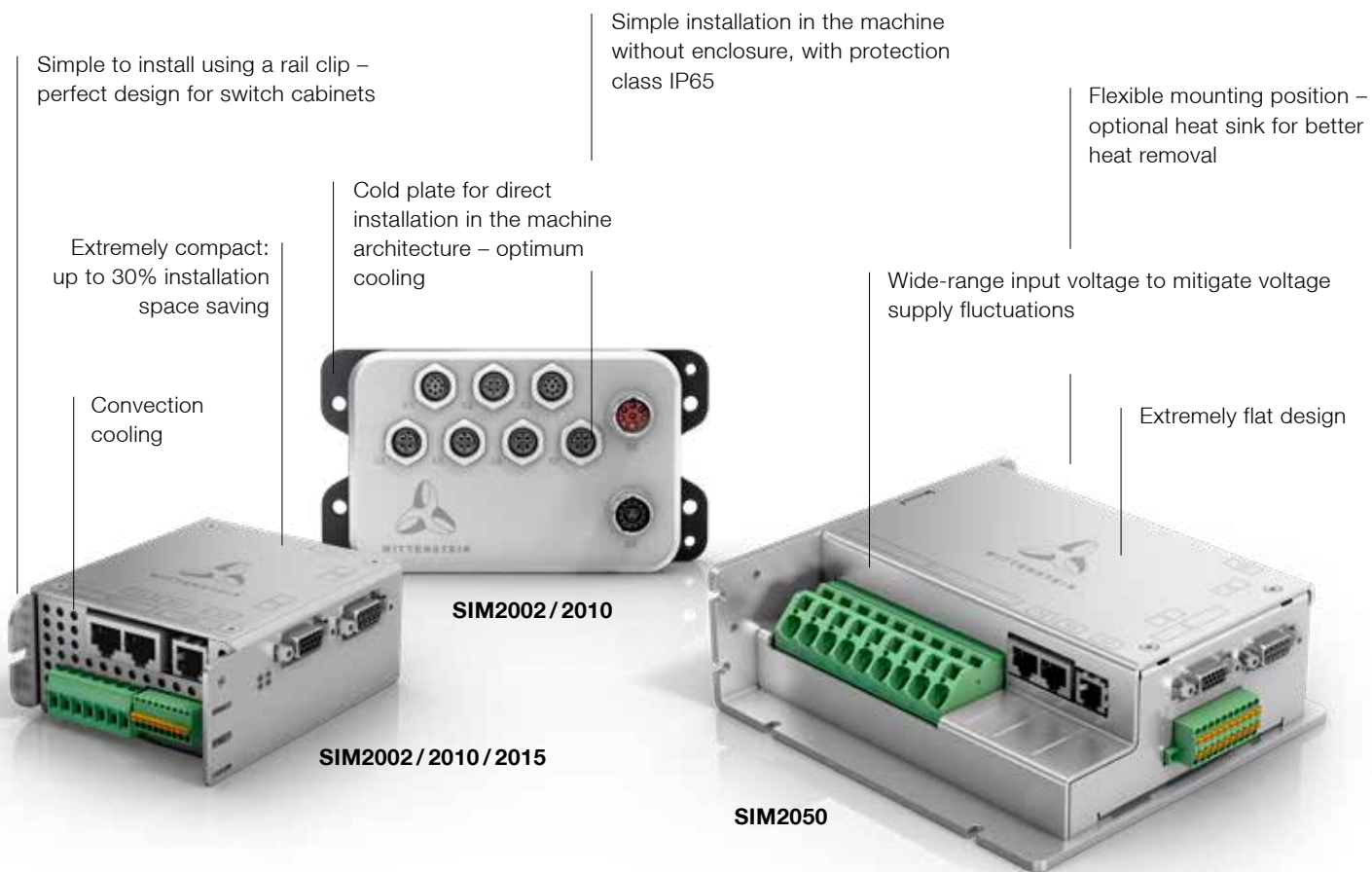

Absolute flexibility

cyber® simco® line has a high number of encoder and fieldbus interfaces in combination with the intuitively operable MotionGUI software. This ensures simple parametrization, optimization and commissioning of the system as well as flexible programming of applications. Regular software updates also enable e.g. the integration of new functions – previous versions remain nonetheless available. Direct analysis of the drive system is possible via the web server. Downtimes are minimized through the optimized fault analysis.

Simple installation

The sophisticated, compact design of the cyber® simco® line is ideally suited for integration in switch cabinets. With integration directly in the machine, the high protection class provides for space saving and the wiring effort is reduced. An electronic type plate, which enables automatic parameterization of the system, is available in combination with the motors from the cyber dynamic line.

WITTENSTEIN offers servo actuators and servo motors as an optimal addition to the servo drives.

High productivity

The switching frequency of 8 - 32 kHz and the current control resolution of 14 bit form the basis for high-precision torque control and dynamic movements. This makes the system ideally suitable for short movements with frequent speed changes, such as occur in e.g. pick & place applications. A mass inertia-optimized motor design enables high acceleration, whereby low downtimes, short cycle times and high machine throughput can be achieved.

Safe in every situation

Best possible application safety

The integrated STO (Safe Torque Off) safety function according to SIL3 / PLe (two-channel) ensures reliable system shut-down in an emergency (disconnection of the torque-generating energy). Furthermore, the supply of logic and power is provided by a reliable galvanic isolation. This means that reinitialization of the drive is not necessary following disconnection of the power supply (e.g. emergency stop).

Comprehensive Condition Monitoring

The web server enables quick and easy status analyses and monitoring of the drive system in the existing network. With its sophisticated features, it ensures continuous transparency and the most simple handling.

cyber[®] simco[®] line MotionGUI software

Intuitive control during commissioning and operation

The MotionGUI graphical user interface guides the user intuitively during commissioning and operation of the drive system.

Diagnoses, optimizations and parametrization of the drive can be performed via a number of functions. Diagnostic routines and event logging are implemented by means of a real-time

clock. Condition monitoring as well as integration and maintenance work can be carried out in an efficient and time-saving way – visible at any time in MotionGUI software.

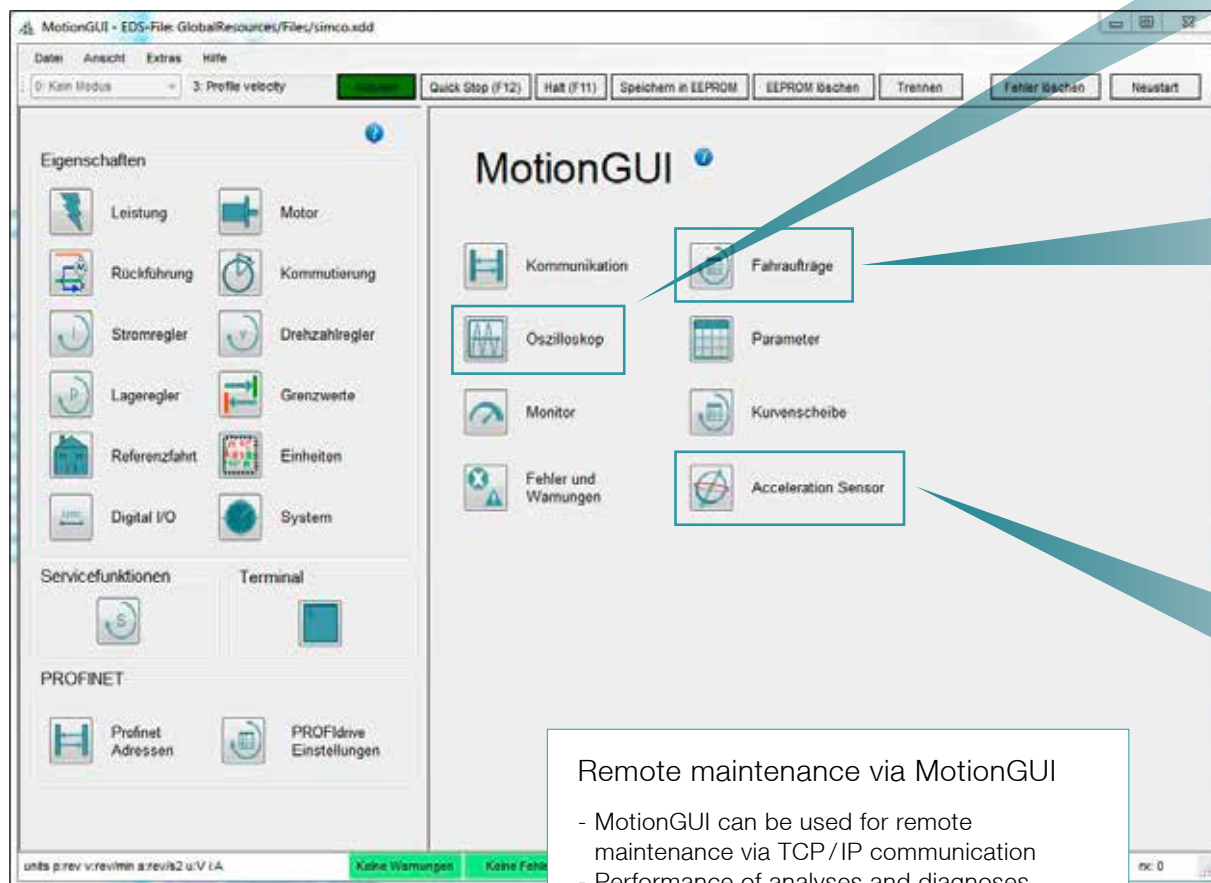

Remote maintenance via MotionGUI

- MotionGUI can be used for remote maintenance via TCP/IP communication
- Performance of analyses and diagnoses in the installed state (e.g. during machine breakdowns)



[SCOPE]
Diagnostic functions

- **SCOPE function**
Analysis of applications and movement sequences via the SCOPE function – also possible in offline mode
- **Errors and Warnings**
Logging of errors and warnings for fast troubleshooting –storage of errors in error history

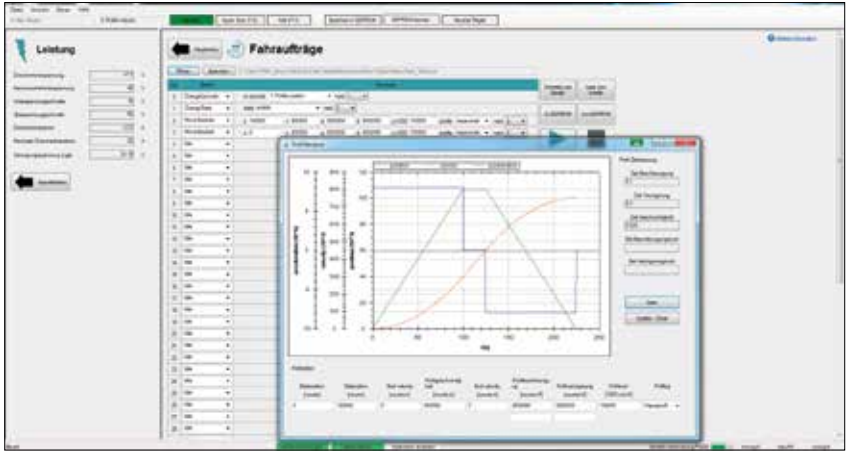

[Motion tasks]
Motion tasks

- Extended motion block table with "decentralized intelligence" for individual modification and flexible programming of the application
- Simple creation of motion tasks with reduced programming effort for the machine manufacturer
- Complex single-axis movements, such as clamping processes or actuation of lifting modules can also be generated and executed decentrally
- In the case of several synchronized axes: movements can be started simultaneously via a synchronization signal from the control system
- Realization of stand-alone solutions by omitting the control system

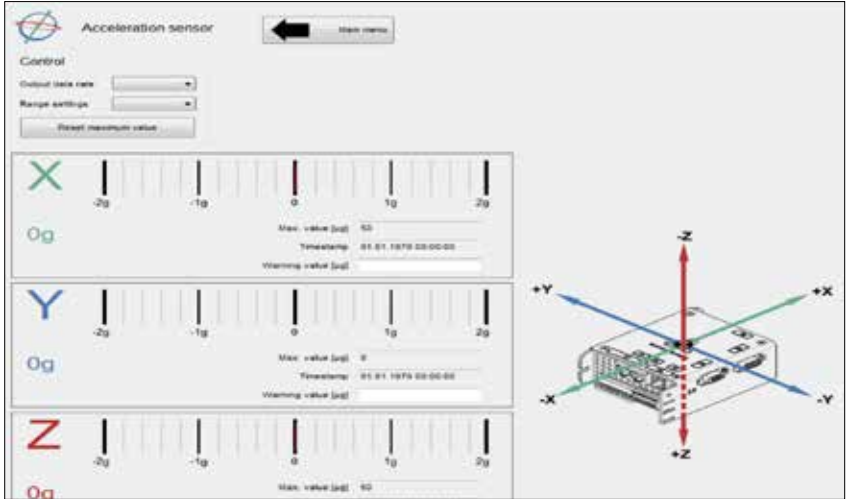

[Acceleration sensor]

Acceleration sensor on board

- Analysis of acceleration values in the x, y, z directions
- Output of warnings and errors when defined maximum acceleration values are exceeded
- Analysis of crashes and the floor conditions of the plant

cyber[®] simco[®] line Web server

Accessing the servo drive via the Internet

Using the web server integrated in the cyber[®] simco[®] line, the servo drive can be accessed via the Internet during mobile operation. This makes it possible to check system utilization and respond

to error or warning messages in an immediate and targeted manner at all times. The intelligent provision of data in the web server also facilitates commissioning and enables permanent

condition monitoring during operational use, which contributes decisively to maximum availability of the entire system.

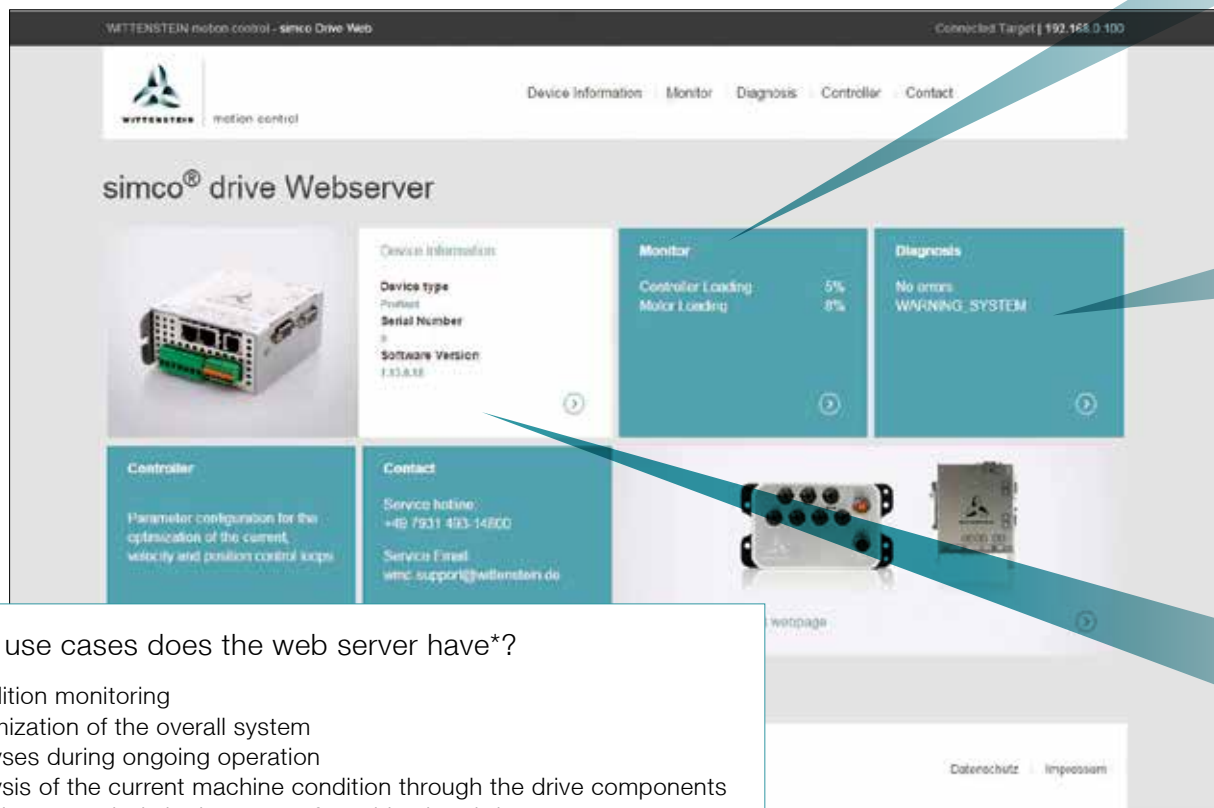

What use cases does the web server have*?

- Condition monitoring
- Optimization of the overall system
- Analyses during ongoing operation
- Analysis of the current machine condition through the drive components
- Rapid error analysis in the event of machine breakdowns
- Practical automation mechanisms for optimized troubleshooting (e.g. mailing support hotline)
- Implementation of measures for long-term error prevention
- Indication of information on the overall system

* The web server is currently available for the PROFINET and EtherNet/IP version of the cyber[®] simco[®] line.



Monitor

Function:

- Analysis of drive parameters during ongoing operation, e.g. temperature, torque, speed
- Determination of motor and servo drive utilization
- Output of diagrams for analysis of the values over time
- Definition of operating / utilization ranges
- Analysis of acceleration values (acceleration sensor)

Your benefits:

- Initiation of measures to optimize the system
- Simple condition monitoring
- Analysis of downsizing potential
- Optimization of operational processes

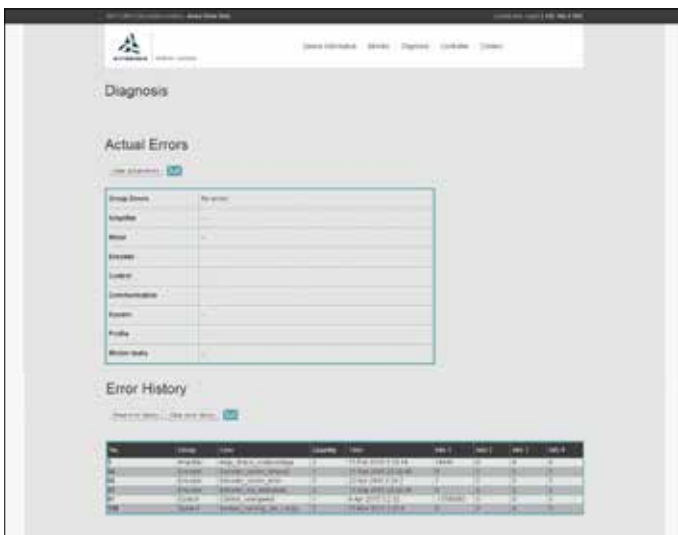

Diagnosis

Functions:

- Output of errors and warnings
- Acknowledgment of errors via the web server
- Display of error history

Your benefits:

- Fast and simple analysis
- Analysis of errors and warnings during ongoing operation
- Initiation of troubleshooting measures
- Solution finding via automated e-mailing of the error codes to the WITTENSTEIN support hotline



Device information

Functions:

- Indication of the device information such as serial number and order code
- Analysis of the overall drive system consisting of the motor and electronics
- Indication of the firmware status used and motor database version
- Display of operating hours

Your benefits:

- Optimal indication of device information
- Fast and simple analysis

cyber[®] simco[®] line

Servo drive for high-performance applications

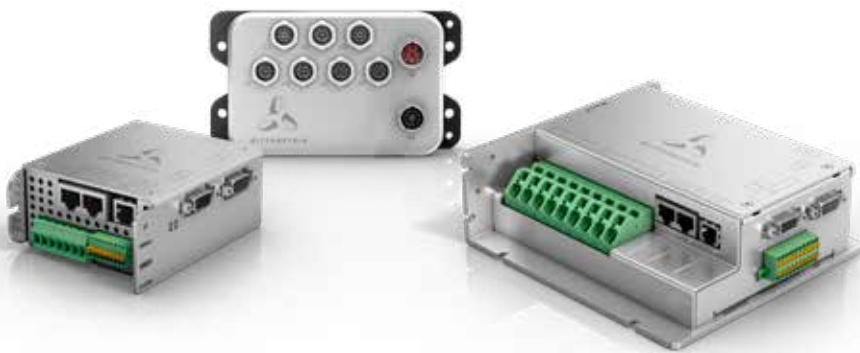

In combination with various servo motors and servo actuators, cyber[®] simco[®] line is the ideal solution for fast and precise moving and positioning tasks. With a continuous output of up to 2.5 kW and a short-term peak output of 5 kW, the cyber[®] simco[®] line is suitable for high-precision applications, e.g. in the machine-tool, electronics or packaging industries – as a switch cabinet version with protection class IP20 or decentralized version with protection class IP65.

intelligent

cyber[®] simco[®] line "thinks" ahead and for you. Integration, commissioning, operability, expansion, configuration, communication: with cyber[®] simco[®] line, everything is designed for simplicity, intuition and efficiency. This saves time and money – and is more than clever.

connective

cyber[®] simco[®] line is open for all applications. Flexible interfaces, intelligent software and technology functions and connection options to a wide range of control systems make the servo drive a multi-talent in process design.

reliable

cyber[®] simco[®] line is reliable. The servo drive series relies on proven components and the control software familiar to the customer. It also offers a maximum degree of transparency, e.g. in fault diagnosis and function monitoring.

Continuous power in watt

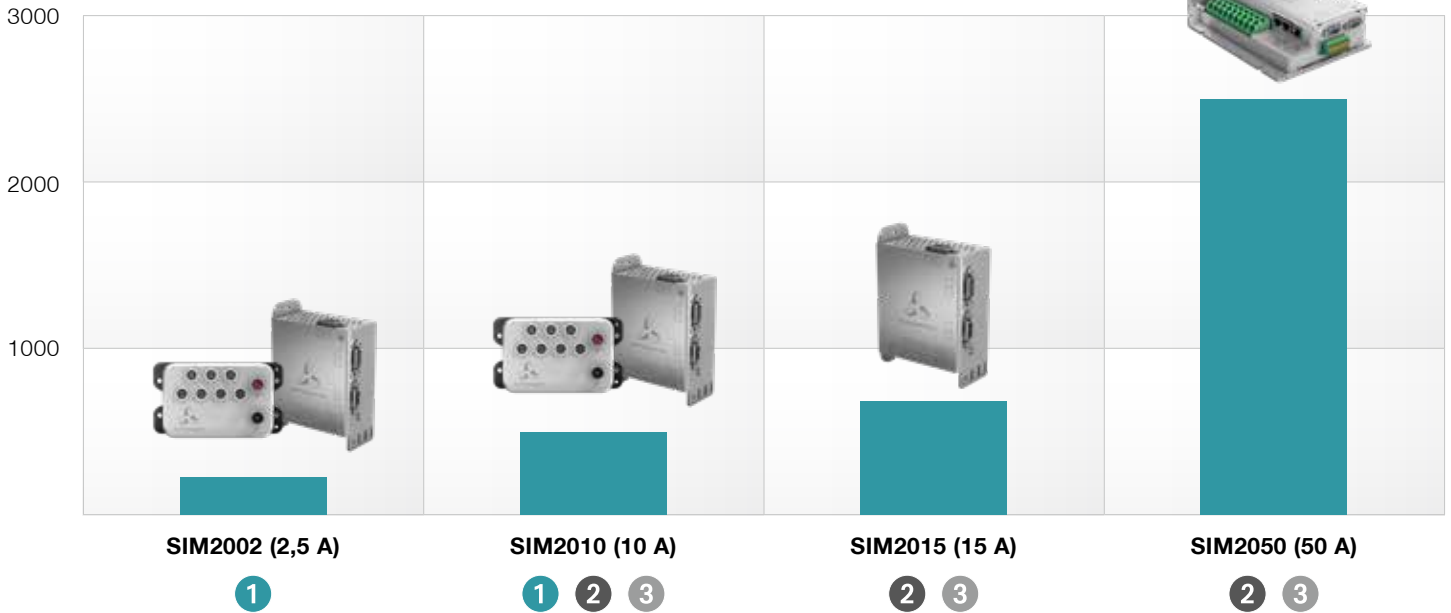

You're looking for a customized drive solution for your performance range?

The versions included here only represent a selection of the many possibilities that can be implemented using the cyber® simco® line system family. Higher-performance versions are available on request.

1



cyber® dynamic line

The cyber® dynamic line and cyber® simco® line make a perfect match: Motor and servo drive from a single source, fast commissioning, single-cable solution, maximum dynamics. Both systems are based on the same development philosophy: Safety, smart technology and resource efficiency at an early stage, while also implementing maximum network capability. Further information is available from page 30.

2



TPM+ dynamic / power

The TPM+ in the dynamic and power versions can be used in size 004 and 010 with the cyber® simco® line servo drive. Intermediate circuit voltages of 24 V and 48 V can be used. A holding brake and the Resolver and EnDat 2.2 encoder versions are available as options. The TPM+ is equipped with either angled or straight integral sockets. Further information is available from page 38.

3

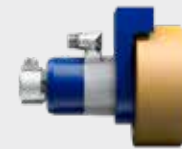

cyber® iTAS® system

TAS is the core unit of the iTAS® drive system. In its diversity, efficiency and individual scalability, our fully integrated, modular servo drive system offers an innovative modular solution specially designed for use in automated guided vehicles. A variety of applications can be individually designed by means of a number of equipment packages.

Detailed information is available in the iTAS® catalog.

Servo drive version			SIM2002D-C	SIM2002D-F	SIM2010D-C	SIM2010D-F	SIM2015-C	SIM2050D-C
Rated output current	I_N	A	2.5	2.5	10	10	15	50
Supply voltage (power)	U_{DC}	V DC	+16 ... 56 (unregulated)	+16 ... 56 (unregulated)	+16 ... 56 (unregulated)	+16 ... 56 (unregulated)	+16 ... +56 (unregulated)	+12 ... +60 (unregulated)
Supply voltage (logic)	U_{log}	V DC	+24 (+/- 10%)	+24 (+/- 10%)	+24 (+/- 10%)	+24 (+/- 10%)	+24 (+/- 10%)	+12 ... +60 (unregulated)
Peak current	I_{max}	A_{eff}	5 (for 5s)	5 (for 5s)	20 (for 5s)	20 (for 5s)	30 (for 5s)	100 (for 5s)
Rated power	P_N	W	125	125	500	500	750	2500
Peak power	P_{max}	W	250	250	1000	1000	1500	5000
Switching frequency	f_{PWM}	kHz	8 ... 32					
Current control resolution		Bit	14	14	14	14	14	14
Communication			CANopen nach DS402; EtherCAT mit CoE; PROFINET RT / IRT; TCP / IP*; RS232; EtherNet / IP; Sercos III	CANopen nach DS402; EtherCAT mit CoE; PROFINET RT / IRT; TCP / IP*; RS232; EtherNet / IP; Sercos III	CANopen nach DS402; EtherCAT mit CoE; PROFINET RT / IRT; TCP / IP*; RS232; EtherNet / IP; Sercos III	CANopen nach DS402; EtherCAT mit CoE; PROFINET RT / IRT; TCP / IP*; RS232; EtherNet / IP; Sercos III	CANopen nach DS402; EtherCAT mit CoE; PROFINET RT / IRT; TCP / IP*; RS232; EtherNet / IP; Sercos III	CANopen nach DS402; EtherCAT mit CoE; PROFINET RT / IRT; TCP / IP*; RS232; EtherNet / IP; Sercos III
Drive function to DS 402 for CANopen / EtherCAT communication			<ul style="list-style-type: none"> - Profile position mode - Homing mode - Profile velocity mode - Profile torque mode - Cyclic synchronous position mode - Cyclic synchronous velocity mode 					
Supported PROFIdrive application classes for PROFINET communication			<ul style="list-style-type: none"> - Application class 1 (PROFINET RT) - Application class 3 (PROFINET RT) - Application class 4 (PROFINET IRT) 					
Encoder interfaces			<ul style="list-style-type: none"> - BISS C - EnDat 2.2*** - Hall sensors - Resolver 					
Safety function			STO (Safe Torque Off) certified according to SIL3/PLe					
Technology functions			Disk cam, motion tasks					
Protection class			IP20	IP65	IP20	IP65	IP20	IP20
Digital inputs			4, opto decoupled, freely programmable function					
Digital outputs			2, opto decoupled, freely programmable function					
Event logging with real-time clock					✓			✓
Brake control					✓			✓
External ballast resistor					✓			
Drive program with PLC functions					✓			✓
Operating temperature range	ϑ_A	°C	0 ... 45**					
Weight	m	kg	0.3	0.85	0.3	0.85	0.3	1.03

* Only available with PROFINET, EtherNet/IP and SERCOS III

** 0...40°C with NRTL conformity for SIM2002D-C, SIM2010D-C and SIM2015D-C

*** not in combination with Sercos III

SIM2002D-C, SIM2010D-C and SIM2015D-C

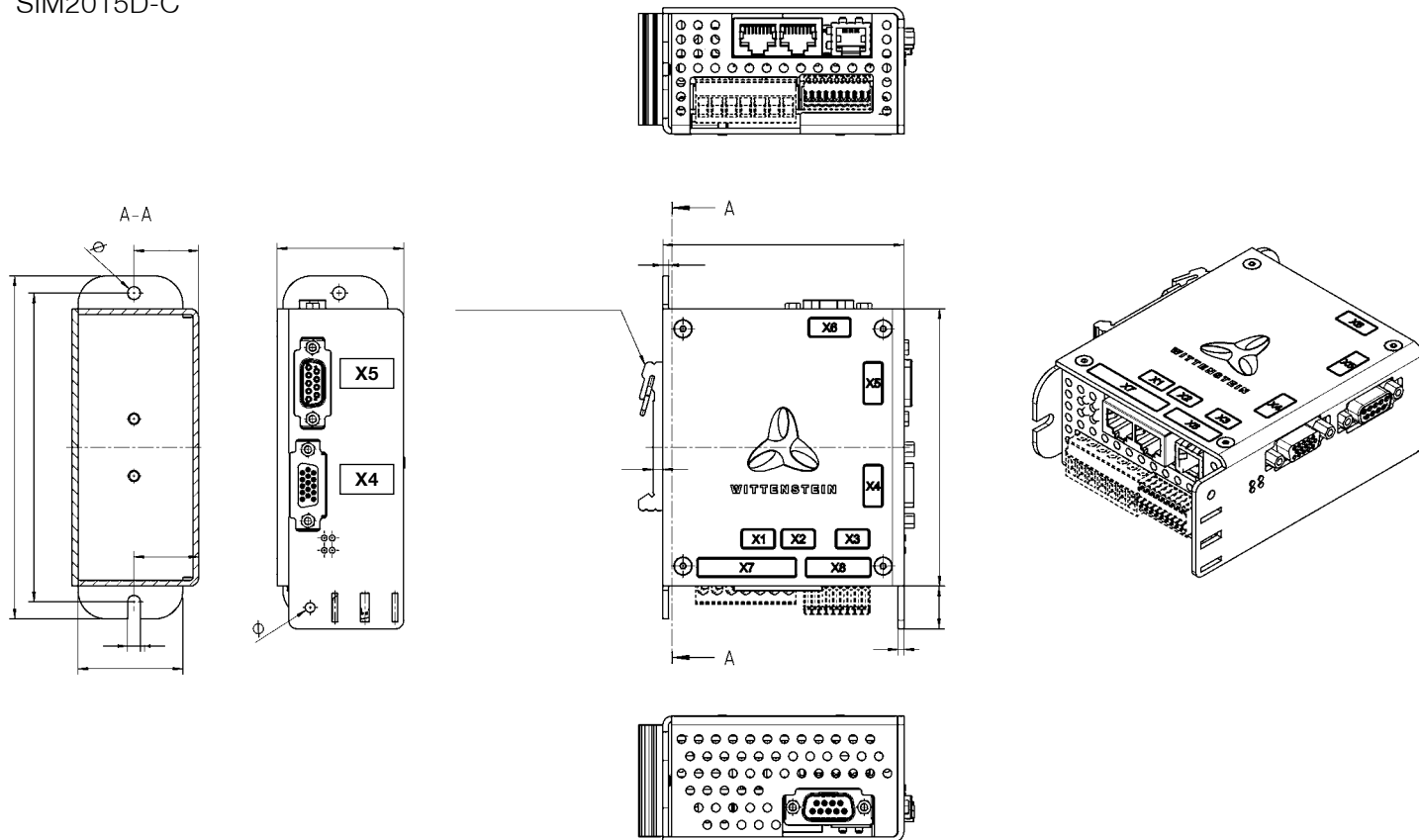

Plug connections

Labelling	Interface type	Plug connection
X1	Input fieldbus interface	RJ45 socket
X2	Output fieldbus interface	RJ45 socket
X3	RS232 diagnostic interface	RJ12 socket
X4	Encoder interface	D-Sub, 15-pin, female
X5	Resolver interface	D-Sub, 9-pin, female
X6	Digital inputs/outputs	D-Sub, 9-pin, male
X7	Motor connection	Phoenix_MSTBA_2.5_HC/7-G
X8	Voltage supply	Phoenix_MC_0.5/9-G-2.5

cyber[®] simco[®] line

SIM2002D-F and SIM2010D-F

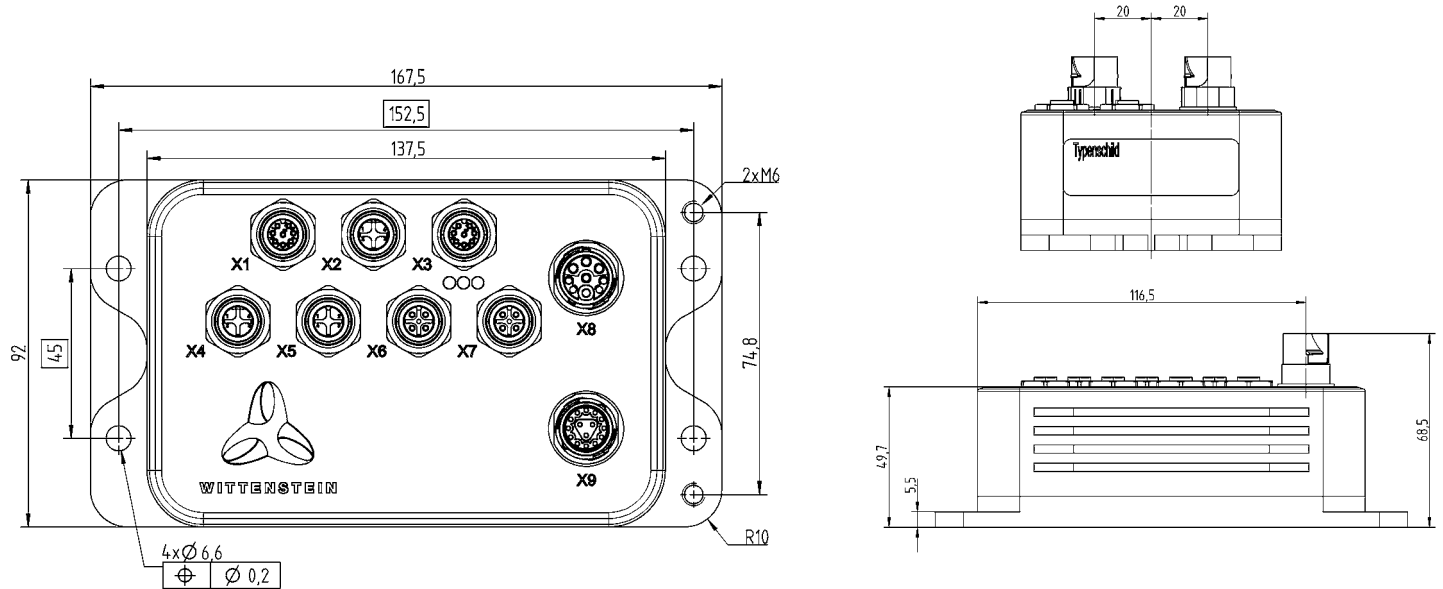

Plug connections

Labelling	Interface type	Plug connection
X1	Resolver interface	M12 8-pin, female, A-coded
X2	Digital inputs	M12 5-pin, female, B-coded
X3	Encoder interface	M12 8-pin, female, A-coded
X4	Digital outputs	M12 5-pin, female, B-coded
X5	RS 232 diagnostic interface	M12 4-pin, female, A-coded
X6	Input fieldbus interface	CANopen version: M12 5-pin, female, A-coded
X7	Output fieldbus interface	CANopen version: M12 5-pin, female, A-coded EtherCAT version M12 4-pin, female, D-coded
X8	Voltage supply	Intercontec itec 915, 9-pin, male
X9	Motor connection	Intercontec itec 915, 15-pin, female

SIM2050D-C

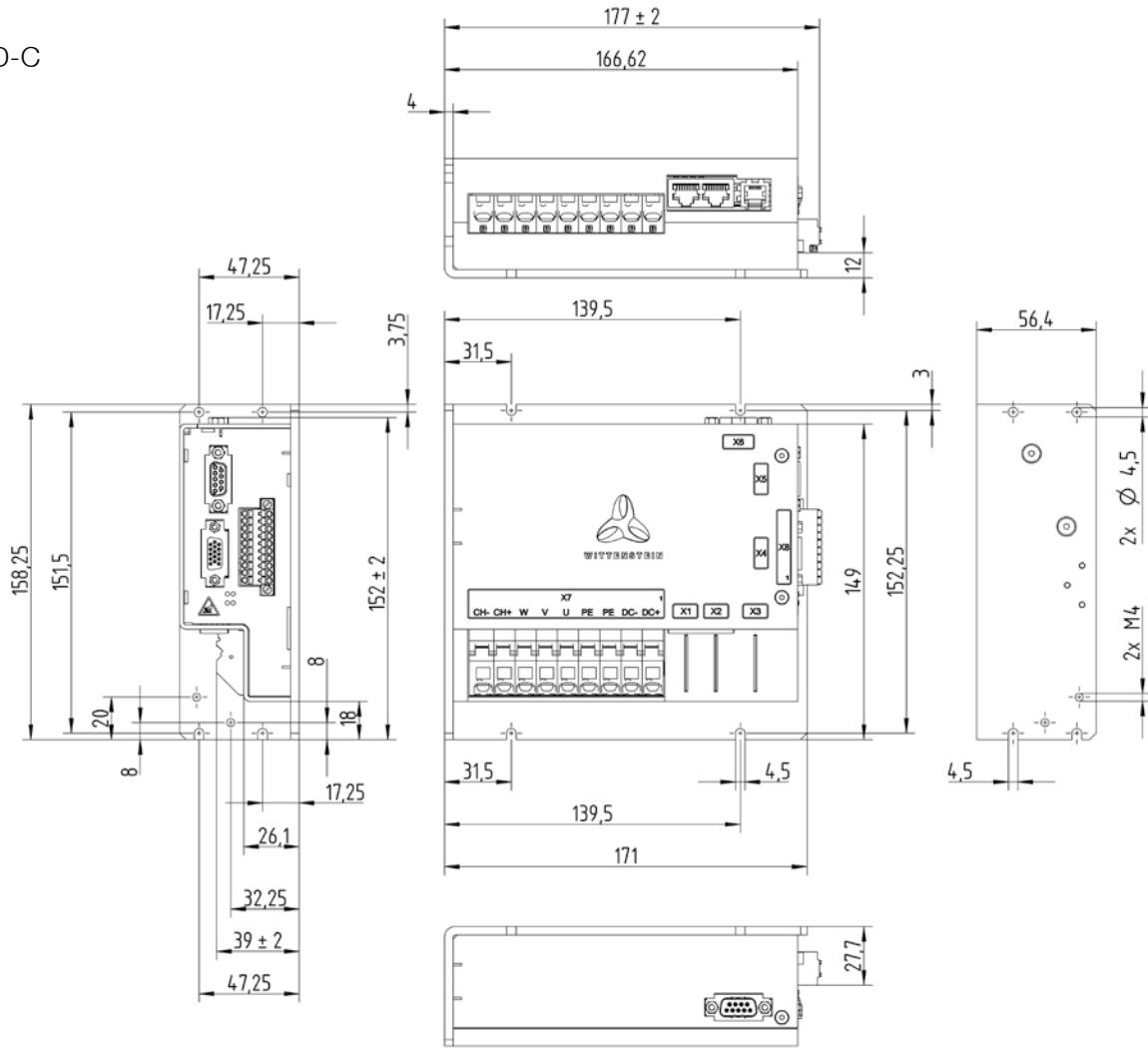

Plug connections

Labelling	Interface type	Plug connection
X1	Input fieldbus interface	RJ45 socket
X2	Output fieldbus interface	RJ45 socket
X3	RS232 diagnostic interface	RJ12 socket
X4	Encoder interface	D-Sub, 15-pin, female
X5	Resolver interface	D-Sub, 9-pin, female
X6	Digital inputs/outputs	D-Sub, 9-pin, male
X7	Motor connection	Phoenix Contact ZFKDS 10-10.00
X8	Voltage supply	Phoenix Contact MC 1.5/10-GF-3.5

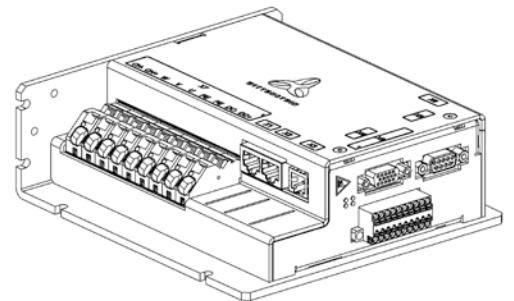

Heat sink available as an accessory. (see page 62)

cyber[®] dynamic line

Brushless servo motors



Industrial design

With a protection class up to IP69K, the cyber® dynamic line is also suitable for use under adverse conditions. The drag-chain compatible, single-cable solution facilitates integration in machines, the stainless-steel housing and the high-strength connection of the motor-gearhead combination ensure a high level of reliability, even in the case of extreme loads. Through the option of decentralized use of the overall drive system, a wide variety of requirements can be addressed in a flexible manner.

High efficiency

The high efficiency of the overall drive system makes it extremely well suited for battery-driven applications. Low losses contribute proactively to increased precision of the overall system. The low losses ultimately result in low heat development in the machine – with high mechanical performance. Fewer cooling surfaces, for example, are required for heat dissipation, achieving significant installation space savings in the machine.

Automatic parametrization

The motor parameters of the cyber® dynamic line are stored in the cyber® simco® line and automatically synchronized with the encoder circuit board by the TID. This electronic type plate makes commissioning particularly uncomplicated, fast and reliable.

Dynamics

The cyber® dynamic line is characterized by a high dynamic factor (maximum torque M_{max} /mass inertia J) and performs short movements with frequent speed changes in an optimal manner (e.g. pick & place). This allows higher accelerations to be achieved – together with shorter downtimes and cycle times in the machine. In addition to this productivity-increasing potential, the low inertia of the motor can effectively help save energy and enhance efficiency.

Torque density / precision

Through the integration of a Sigma/Delta converter and a current measurement under $8 \mu s$, cyber® simco® line provides a current resolution of 1.2 mA (14 bit). This results in a low torque and speed ripple, allowing the application to be controlled with a high level of precision. Thanks to its low weight and compact design, the high-precision cyber® dynamic line not only contributes effectively to efficiency enhancements in the machine, but these characteristics are also particularly well-suited for use in moving axes. The option for downsizing of the entire drive train leads to measurable cost savings.

cyber[®] dynamic line

Servo motor

Size			17	22	32	40
Intermediate circuit voltage	U_{DC}	V_{DC}	48	48	48	48
Max. torque	M_{max}	Nm	0.035	0.07	0.33	0.96
Continuous stall torque	M_0	Nm	0.012	0.034	0.14	0.35
No-load speed	n_0	rpm	21100	14450	9475	5575
Continuous stall current	I_0	A_{eff}	0.52	0.96	2.6	3.8
Moment of inertia	J_1	$kgm^2 \cdot 10^{-8}$	5.2	12	57	250
Weight	m	kg	0,11*	0,15*	0,33*	0,54*
Ambient temperature	ϑ_A	°C	0 to +40			
Protection class, standard (mounted)	-	IP	54			
Protection class, Inox Design (mounted)	-	IP	66/67			
Encoder			Absolute encoder Singleturn with BISS-C Interface (HI): Resolution 12 Bit or Incremental encoder with commutation tracks (HF): Resolution 1024 Increments			

*Standard Design incl. 0,5m cable and connector

Inox Design / Hygienic Design



Type	Inox Design	Hygienic Design
Size (outer diameter in mm)	17 / 22 / 32 / 40	40
Protection class (mounted)	IP66 / 67	IP69K
Contact surfaces	Corrosion-resistant stainless steel	Corrosion-resistant stainless steel
Design	Standard	Hygienic design (according to EHEDG)
Lubrication	Standard	Food-grade
Certification	UL (cRUus) for size 32 / 40	EHEDG (in certification)
Gearhead option	For all sizes	For all sizes
Ball screw option	For all sizes	no

Standard:

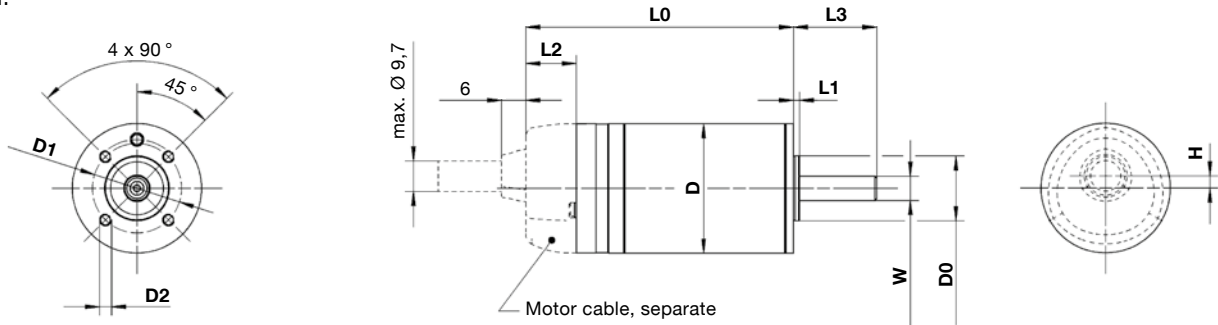

Inox Design:

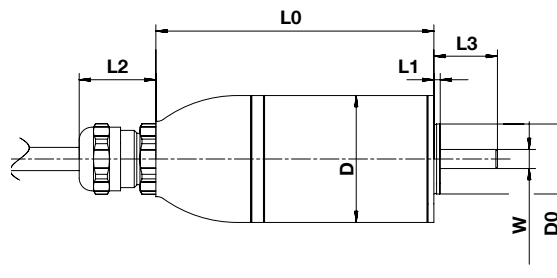

Hygienic Design:

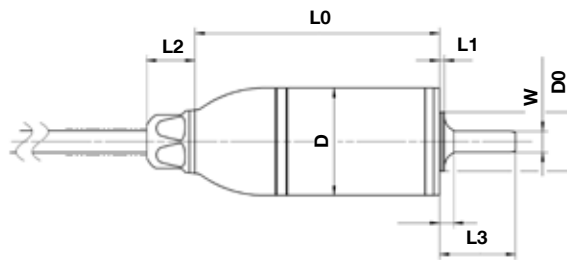

Size	17		22		32		40		
Type	Standard	Inox	Standard	Inox	Standard	Inox	Standard	Inox	Hygienic
D	17		22		32		40		
D0	10		13		16		22		
D1	12,5		17		22		32		30
D2	M1,6x2,5		M2x3,5		M3x4,5		M3x4,5		M3x4
W	3		4		6		6		8
L0	47	54,4	49,1	57,9	66,1	74,6	80,3	87,4	90,4
L1	1,2		1,5		1,5		2		
L2	13,3	20	12,4	20	12,5	22	14,5	22	18
L3	10		12		20,6		20		28,5
H	0		0		3		7,5		
Shaft type	Plain shaft								

cyber[®] dynamic actuator R

Servo actuator – size 17

No. of stages			1	2			3		
Ratio	i	–	4	12	21	28	36	48	64
Maximum torque	M_{max}	Nm	0,1	0,28	0,49	0,63	0,78	1,0	1,0
Continuous stall torque	M_0	Nm	0,03	0,08	0,14	0,19	0,22	0,29	0,37
Rated torque	M_n	Nm	0,02	0,06	0,1	0,13	0,15	0,2	0,27
No-load speed	n_{max}	min ⁻¹	2.500	830	475	355	275	210	150
Permanently permitted speed	$n_{max, S1}$	min ⁻¹	1.500	500	285	215	165	125	90
Continuous stall current	I_0	A_{eff}	0,37	0,37	0,37	0,37	0,37	0,37	0,37
Weight	–	kg	0,14*	0,15*			0,15*		
Backlash	j_l	arcmin	20	35			50		
Max. axial force	F_{amax}	N	10						
Max. radial load	F_{max}	N	30						
Protection class, standard (mounted)	–	IP	54						
Protection class, Inox Design (mounted)	–	IP	66/67						
Shaft type			D-Cut shaft						

* Standard Design incl. 0,5m cable and connector

Standard:

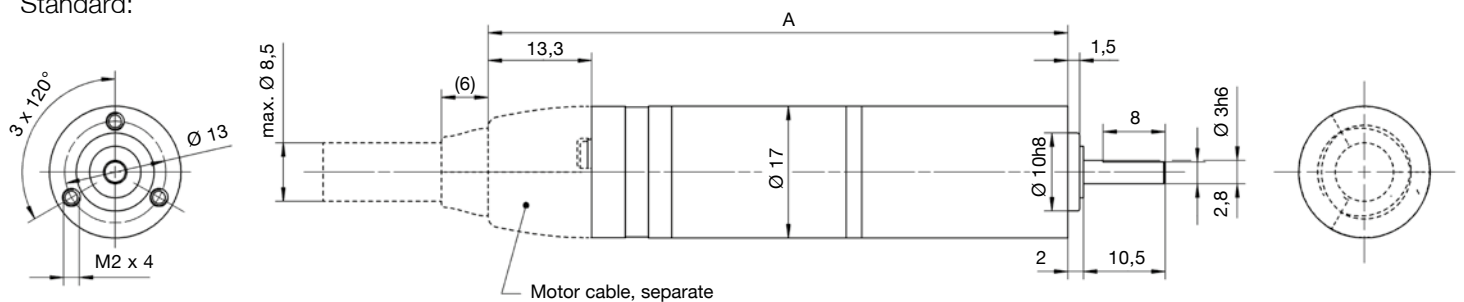

Inox Design:

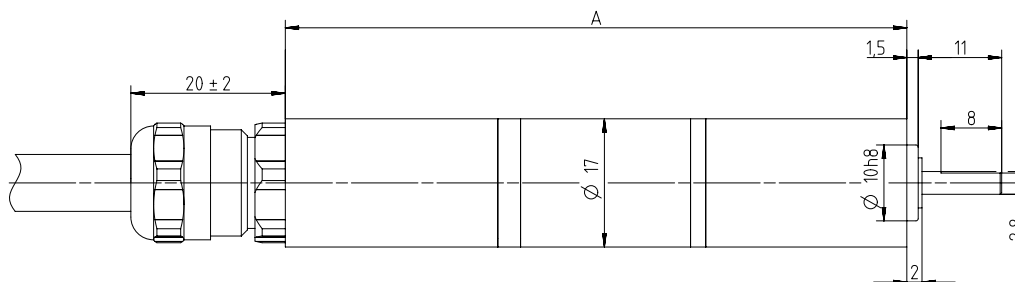

Ratio	Length A [mm]	Length A [mm] (Inox Design)
Single-stage, i4	64,5	71,9
Two-stage, i12/21/28	69,5	76,9
Three-stage, i36/48/64	74,5	81,9

cyber[®] dynamic actuator R

Servo actuator – size 22



cyber motor

No. of stages			1	2	3		
Ratio	i	–	4	16	20	28	64
Maximum torque	M_{max}	Nm	0,2	1,0	1,0	1,0	1,5
Continuous stall torque	M_0	Nm	0,1	0,43	0,5	0,5	1,34
Rated torque	M_n	Nm	0,1	0,39	0,48	0,5	1,2
No-load speed	n_{max}	min ⁻¹	2.500	625	500	360	155
Permanently permitted speed	$n_{max, S1}$	min ⁻¹	1.500	375	300	215	95
Continuous stall current	I_0	A_{eff}	0,74	0,84	0,79	0,58	0,75
Weight	–	kg	0,20*	0,21*		0,22*	
Backlash	j_t	arcmin	20	35		50	
Max. axial force	F_{amax}	N	24				
Max. radial load	F_{max}	N	30				
Protection class, standard (mounted)	–	IP	54				
Protection class, Inox Design (mounted)	–	IP	66/67				
Shaft type			D-Cut shaft				

* Standard Design incl. 0,5m cable and connector

Standard:

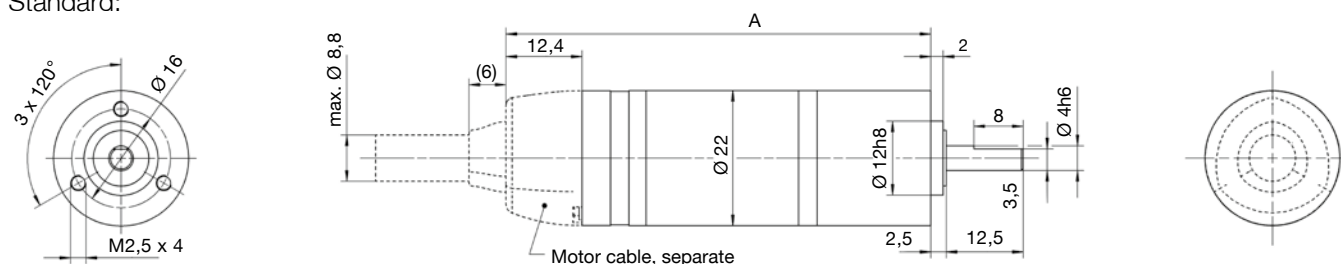

Inox Design:

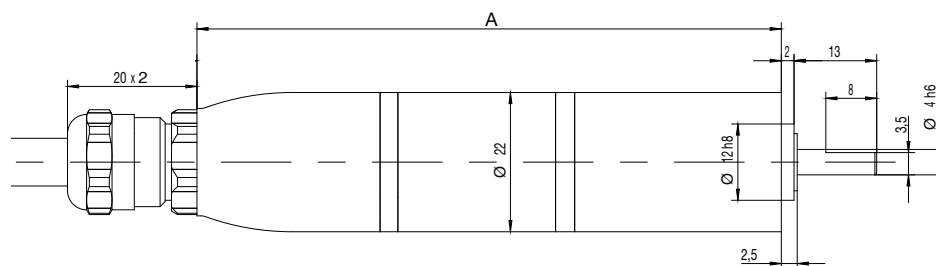

Ratio	Length A [mm]	Length A [mm] (Inox Design)
Single-stage, i4	69,1	77,9
Two-stage, i12/21/28	76,1	84,9
Three-stage, i36/48/64	83,1	91,9

cyber[®] dynamic actuator R

Servo actuator – size 32

No. of stages			1	2			3		
Ratio	i	–	4	16	20,8	25	64	72	100
Maximum torque	M_{max}	Nm	0,8	4,0	4,0	4,0	6,0	6,0	6,0
Continuous stall torque	M_o	Nm	0,4	1,5	2,0	2,0	5,7	6,0	6,0
Rated torque	M_n	Nm	0,4	1,4	1,8	2,0	5,1	5,8	6,0
No-load speed	n_{max}	min ⁻¹	2.000	500	385	320	125	111	80
Permanently permitted speed	$n_{max, S1}$	min ⁻¹	1.250	313	240	200	78	69	50
Continuous stall current	I_o	A_{eff}	2,0	2,0	2,0	1,8	2,0	1,9	1,4
Weight	–	kg	0,47*	0,51*			0,56*		
Backlash	j_t	arcmin	20	35			50		
Max. axial force	F_{amax}	N	65						
Max. radial load	F_{max}	N	80						
Protection class, standard (mounted)	–	IP	54						
Protection class, Inox Design (mounted)	–	IP	66/67						
Shaft type			Plain shaft						

* Standard Design incl. 0,5m cable and connector

Standard:

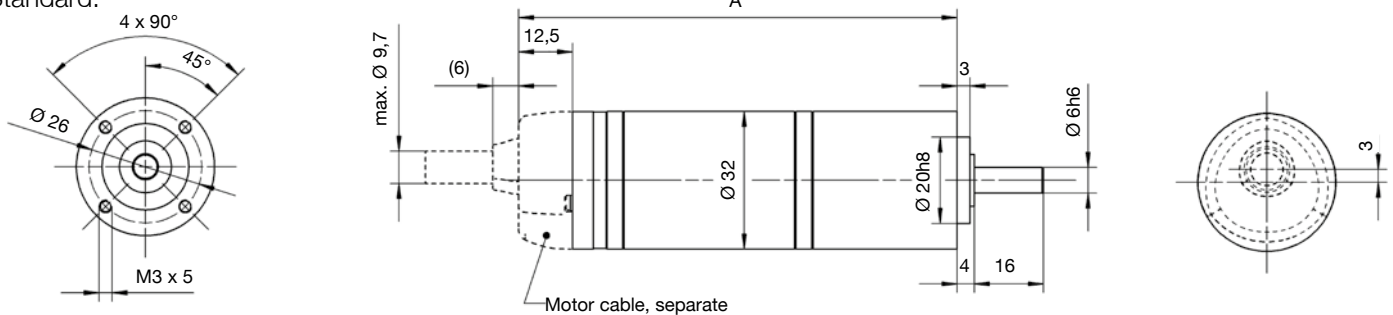

Inox Design:

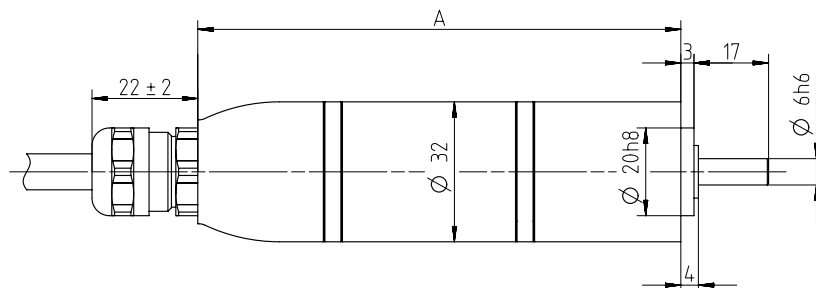

Ratio	Length A [mm]	Length A [mm] (Inox Design)
Single-stage, i4	92,6	101,1
Two-stage, i12/21/28	101,6	110,1
Three-stage, i36/48/64	110,6	119,1

cyber[®] dynamic actuator R

Servo actuator – size 40

No. of stages			1	2				3		
Ratio	i	–	4	12,25	20	25	30,67	49	64	100
Maximum torque	M_{max}	Nm	1,4	8,0	8,0	8,0	8,0	12,0	12,0	12,0
Continuous stall torque	M_0	Nm	0,7	3,1	4,0	4,0	4,0	11,8	12,0	12,0
Rated torque	M_n	Nm	0,7	2,5	4,0	4,0	4,0	9,4	12,0	12,0
No-load speed	n_{max}	min ⁻¹	1.400	455	280	220	182	114	87	56
Permanently permitted speed	$n_{max, S1}$	min ⁻¹	1.250	400	250	200	160	100	78	50
Continuous stall current	I_0	A_{eff}	2,0	3,1	2,5	2,0	1,6	3,1	2,5	1,7
Weight	–	kg	0,8*	0,89*				0,95*		
Backlash	j_t	arcmin	20	35				50		
Max. axial force	F_{amax}	N	120							
Max. radial load	F_{max}	N	150							
Protection class, standard (mounted)	–	IP	54							
Protection class, Inox Design (mounted)	–	IP	66 / 67							
Shaft type	Shaft with keyway									

* Standard Design incl. 0,5m cable and connector

Standard:

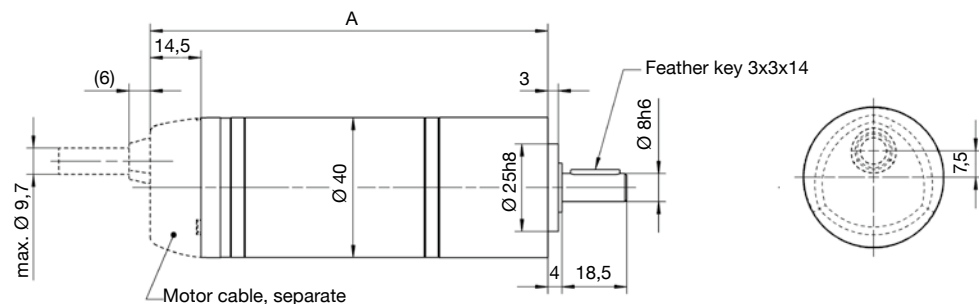
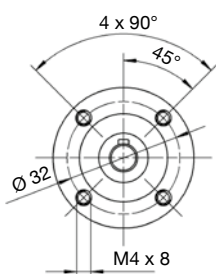

Inox Design:

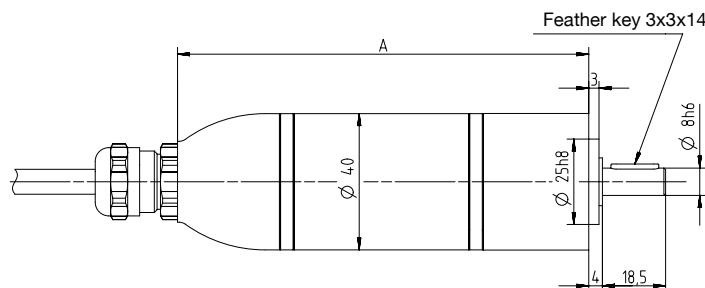

Ratio	Length A [mm]	Length A [mm] (Inox Design)
Single-stage, i4	113,3	120,4
Two-stage, i12/21/28	125,8	132,9
Three-stage, i36/48/64	138,3	145,4

cyber[®] dynamic actuator R

Servo actuator – size 40 in Hygienic Design

No. of stages	i	–	1		2	
			4	5	16	50
Ratio	i	–	4	5	16	50
Maximum torque	M_{max}	Nm	3,2	4,0	8,4	8,4
Continuous stall torque	M_0	Nm	1,1	1,0	4,2	4,2
Rated torque	M_n	Nm	0,91	0,76	3,65	4,2
No-load speed	n_{max}	min ⁻¹	1400	1120	350	110
Permanently permitted speed	$n_{max, S1}$	min ⁻¹	100	800	250	80
Continuous stall current	I_0	A_{eff}	3,1	2,4	3,0	1,05
Weight	–	kg	0,92*		1,13*	
Backlash	j_t	arcmin	20		25	
Max. axial force	F_{amax}	N	230			
Max. radial load	F_{max}	N	200			
Protection class (mounted)	–	IP	IP69K			
Shaft type			Shaft with keyway			

* Standard Design incl. 0,5m cable and connector

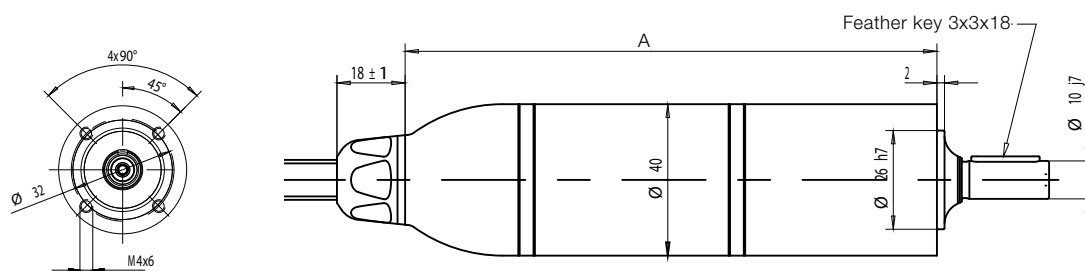

Ratio	Length A [mm]
Single-stage, i4	124,6
Two-stage, i12/21/28	140,1

cyber[®] dynamic line

Linear actuator

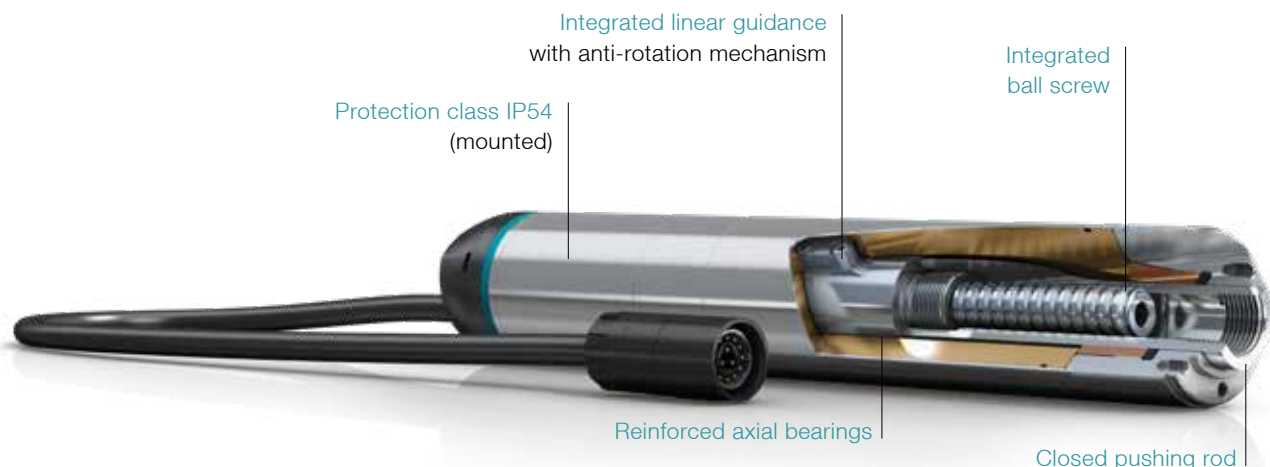

Industrial-grade design

With the linear actuators in the cyber[®] dynamic line, the screw is fully integrated in the actuator housing – the servo motor, spindle drive, linear guide and encoder system form a closed, highly integrated and ready-to-install unit. All sizes moreover feature an absolute encoder and are designed using EMC shielded, single-cable technology that is compatible with drag chains. Thanks to these innovative features, the drives are perfect for industrial applications.

Power density & dynamics

The small servo motors with integrated screw impress with their high power density and dynamics. Each of the four sizes has two different screw pitches, making them ideal for applications, which are either force- or speed optimized. The linear actuators additionally have a compact design, which results in much lower mass inertia than feasible, for instance, if the screw is simply attached to the servo motor.

Maintenance-free system

The linear actuators are lifetime lubricated, so that no maintenance is required. The closed thrust tube has an integrated scraper to prevent dirt from getting onto the screw. Furthermore, the spindle drive with reinforced bearings allows both a tensile and a compressive force to be applied.

Process reliability

Unlike pneumatic cylinders, the linear actuators permit precise and flexible position control regardless of the application without any retooling on the machine. They are thus ideal whenever frequent format changes are likely. The servo technology offers better controllability by design; together with the easy integration into a higher-level controller, this facilitates reproducible processes that can be realized either position or force controlled.

cyber[®] dynamic actuator L

Linear actuator – size 17

Size			17	
Screw pitch	p_{SP}	mm	1	3
Maximum axial force	F_{AMax}	kN	0,2	0,065
Continuous stall force	F_0	kN	0,055	0,018
Maximum velocity (without external load)	v_0	mm/s	100	300
Positioning accuracy	-	mm	up to 0,05	
Repeat accuracy	-	mm	0,01	
Maximum stroke (Short version)	s	mm	30	
Maximum stroke (Long version)	s	mm	120	
Weight (Short version)		kg	0,23	
Weight (Long version)		kg	0,33	
Protection class, Standard (mounted)	-	IP	54	
Protection class, Inox Design (mounted)	-	IP	66 / 67	

Standard:

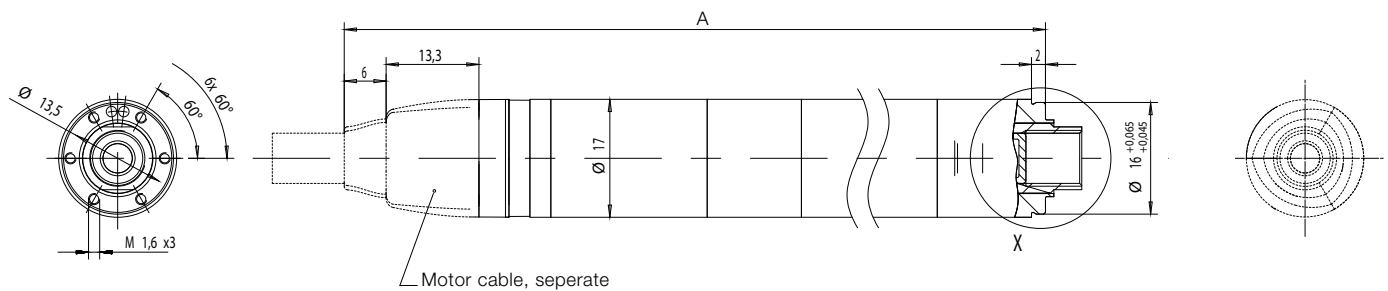

Inox Design:

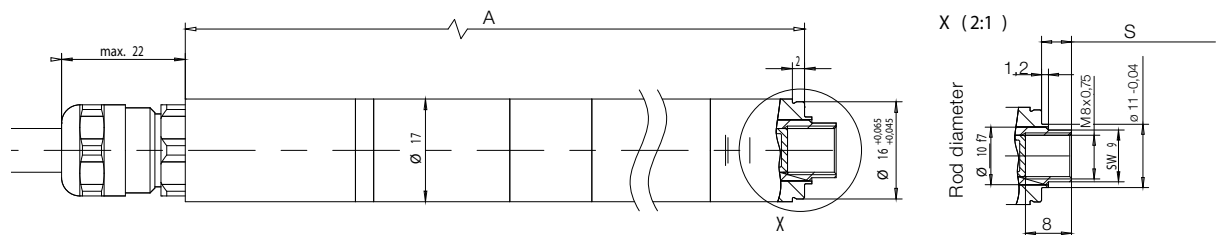

	Length A [mm]	Length A [mm] (Inox Design)	Stroke S [mm]
Short stroke	146	147,4	5,2 - 35,2 (=30 mm)
Long stroke	236	237,4	5,2 - 125,2 (=120 mm)

cyber[®] dynamic actuator L

Linear actuator – size 22



WITTENSTEIN

cyber motor

Size			22	
Screw pitch	p_{SP}	mm	1	6
Maximum axial force	F _{AMax}	kN	0,4	0,065
Continuous stall force	F ₀	kN	0,15	0,025
Maximum velocity (without external load)	v ₀	mm/s	100	600
Positioning accuracy	-	mm	up to 0,05	
Repeat accuracy	-	mm	0,01	
Maximum stroke (Short version)	s	mm	35	
Maximum stroke (Long version)	s	mm	140	
Weight (Short version)		kg	0,39	
Weight (Long version)		kg	0,62	
Protection class, Standard (mounted)	-	IP	54	
Protection class, Inox Design (mounted)	-	IP	66 / 67	

Standard:

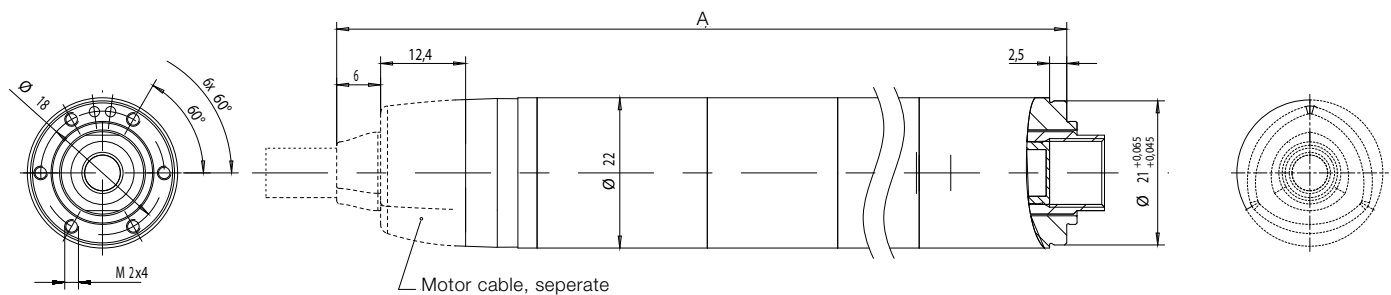

Inox Design:

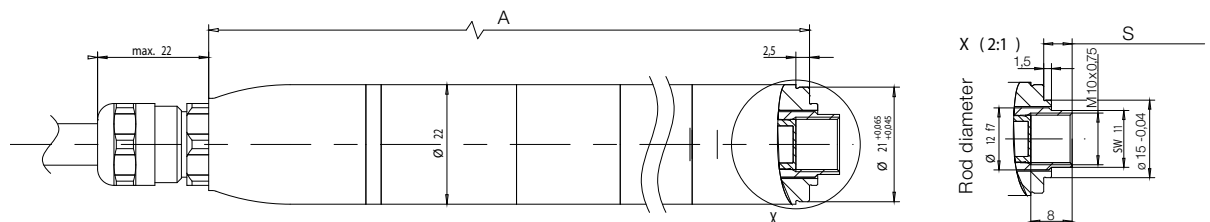

	Length A [mm]	Length A [mm] (Inox Design)	Stroke S [mm]
Short stroke	170,5	172,9	5,5 – 40,5 (=35 mm)
Long stroke	275,5	277,9	5,5 – 145,5 (=140 mm)

cyber[®] dynamic actuator L

Linear actuator – size 32

Size			32	
Screw pitch	p_{SP}	mm	2	8
Maximum axial force	F_{AMax}	kN	1,0	0,25
Continuous stall force	F_0	kN	0,334	0,08
Maximum velocity (without external load)	v_0	mm/s	200	800
Positioning accuracy	-	mm	up to 0,05	
Repeat accuracy	-	mm	0,01	
Maximum stroke (Short version)	s	mm	40	
Maximum stroke (Long version)	s	mm	160	
Weight (Short version)		kg	1,0	
Weight (Long version)		kg	1,6	
Protection class, Standard (mounted)	-	IP	54	
Protection class, Inox Design (mounted)	-	IP	66 / 67	

Standard:

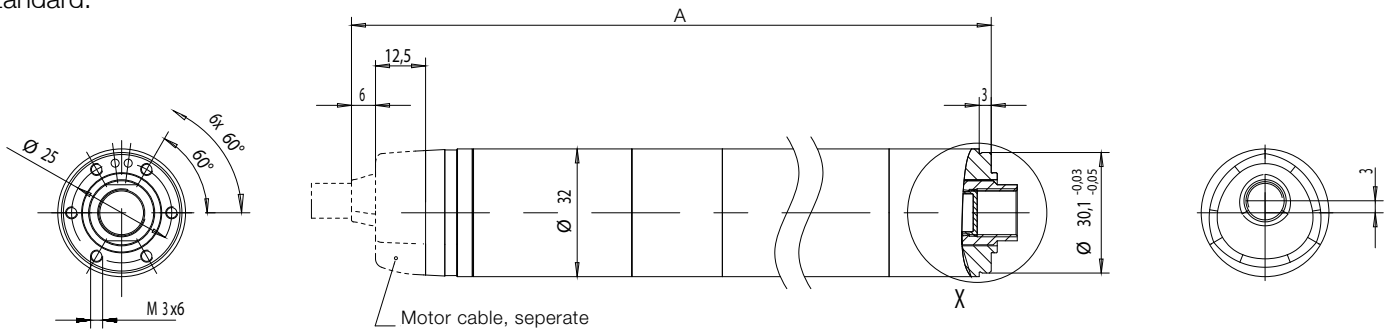

Inox Design:

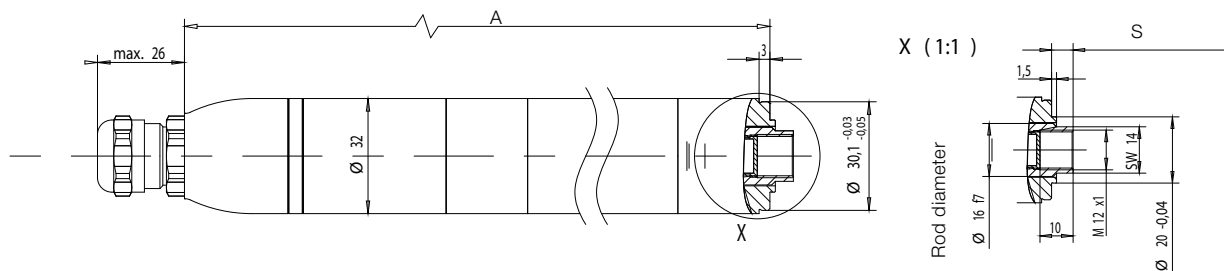

	Length A [mm]	Length A [mm] (Inox Design)	Stroke S [mm]
Short stroke	205,1	207,6	6,5 – 46,5 (=40 mm)
Long stroke	325,1	327,6	6,5 – 166,5 (=160 mm)

cyber[®] dynamic actuator L

Linear actuator – size 40

Size			40	
Screw pitch	p_{SP}	mm	3	10
Maximum axial force	F_{AMax}	kN	2,0	0,6
Continuous stall force	F_0	kN	0,575	0,17
Maximum velocity (without external load)	v_0	mm/s	280	900
Positioning accuracy	-	mm	up to 0,05	
Repeat accuracy	-	mm	0,01	
Maximum stroke (Short version)	s	mm	50	
Maximum stroke (Long version)	s	mm	200	
Weight (Short version)		kg	1,8	
Weight (Long version)		kg	3,2	
Protection class, Standard (mounted)	-	IP	54	
Protection class, Inox Design (mounted)	-	IP	66 / 67	

Standard:

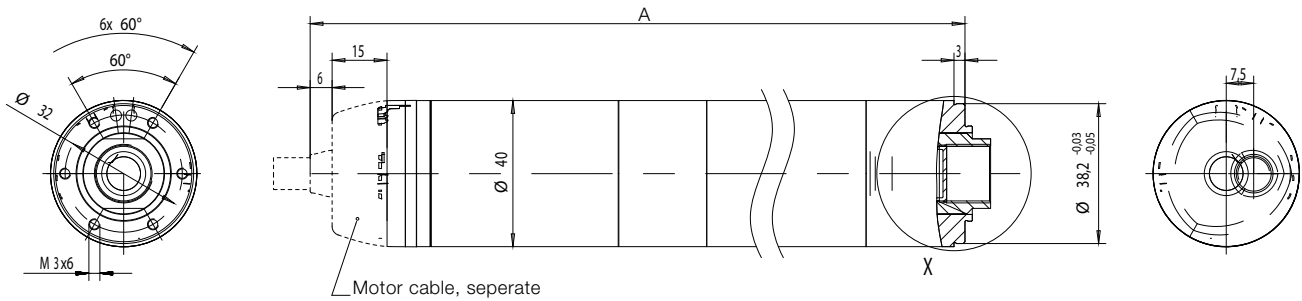

Inox Design:

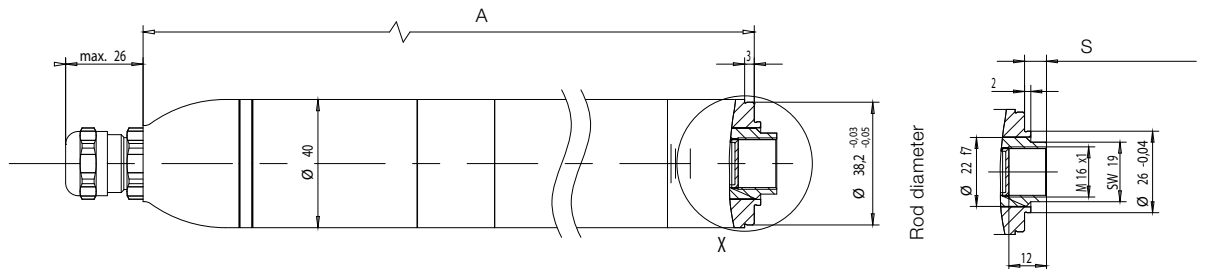

	Length A [mm]	Length A [mm] (Inox Design)	Stroke S [mm]
Short stroke	245,3	246,4	7 – 57 (=50 mm)
Long stroke	395,3	396,4	7 – 207 (=200 mm)

TPM⁺ Actuator



Compact servo actuator series

The perfect combination for all requirements: The TPM⁺ servo actuators in the dynamic and power versions optimally complement the cyber[®] simco[®] line. The compact and dynamic actuators combine the gearhead and servo motor to form a coupling-free, flexibly usable unit. The versions of the TPM⁺ series shown here only represent a selection of the wide-ranging possibilities offered by these servo actuators in practice. We will be pleased to provide further versions upon request.



Motor/gearhead combination

The particularly compact dimensions of the TPM+ enable effective installation space savings in the machine and in the switch cabinet (servo drive).

Outstanding dynamics

Through use of the high-performance TPM+ productivity can be increased in a targeted manner in the machine because of the coupling-free connection between motor and gearhead. The low momentum of inertia and the high torsional rigidity lead to particular short response times in the machine.

High variety

The application-specific sizing of the series provides for an optimized selection of solutions to meet your individual requirements. Through various optional equipment criteria, e.g. in terms of size or encoder systems, there is a high level of flexibility in the further specification of the motor/gearhead combination. Moreover, the servo drive used can be precisely matched to the required actuator power version, additionally optimizing the compactness and efficiency of the overall drive system.

Perfectly matched

With the complete drive systems of WITTENSTEIN (cable, drive, actuator), commissioning is particularly easy: The motor data of the TPM+ actuator series is stored in the motor database of the cyber® simco® line, so that parametrization takes place exclusively through selection of the motor version in the software. This not only saves time, but also helps to prevent any errors during commissioning or during operation.

Problem-free performance enhancement

Through expansion of the cyber® simco® line performance up to 6 kW, the performance of the entire drive train can be extended accordingly. In addition to the versions included in this catalog, size 025 and 050 actuators can also be used. A wide range is therefore covered and TPM+ with cyber® simco® line can be used for additional axes and in new applications.

TPM+ dynamic

Size 004

Ratio	i		16	21	31	61	64	91
Motor size			53-30	53-30	53-30	53-15	53-15	53-15
Intermediate circuit voltage	U_D	V DC	48	48	48	48	48	48
Max. acceleration torque at output (max. 1000 cycles per hour)	T_{2B}	Nm	28,6	32	40	32	32	32
Static output torque	T_{20}	Nm	8	10,9	16,4	15	14,1	15
Brake holding torque at output, 100°C	T_{2BR}	Nm	17,6	23,1	34,1	67,1	70,4	100
Max. speed	n_{2max}	min ⁻¹	375	286	194	98,4	93,8	65,9
Speed limit for T2B	n_n	min ⁻¹	275	209	142	95	85,9	63,5
Max. motor acceleration torque	T_{mmax}	Nm	1,25	1,25	1,25	1,03	1,03	1,03
Max. motor acceleration current	I_{maxdyn}	A_{eff}	30	30	30	30	30	30
Motor stall current	I_0	A_{eff}	11,2	11,2	15	15	15	15
Mass moment of inertia (at motor shaft, without brake, with resolver)	J_1	kgm ² *10 ⁻⁴	0,21	0,2	0,2	0,12	0,11	0,12
Backlash	j_t	arcmin	Standard < 4 / Reduced < 2					
Torsional rigidity	C_t	Nm/ arcmin	/	10	9	9	/	7
Tilting rigidity	C_K	Nm/ arcmin	/					
Max. axial force	F_{amax}	N	1630					
Max. tilting torque (distance from point of rotation to output flange 57.6 mm)	M_{kmax}	Nm	110					
Weight (with resolver, without brake)	m	kg	2,2			2		
Operating noise (measured at motor speed of 3000 rpm)	L_{PA}	dB(A)	< 58					
Max. permitted housing temperature	ϑ_{max}	°C	90					
Ambient temperature	ϑ_U	°C	0 bis +40					
Protection class			IP65					
Mounting position			Any					
Lubrication			Synthetic oil, lubricated for life					
Insulating material class			F					
Paint			Metallic blue 250 and natural cast aluminum					

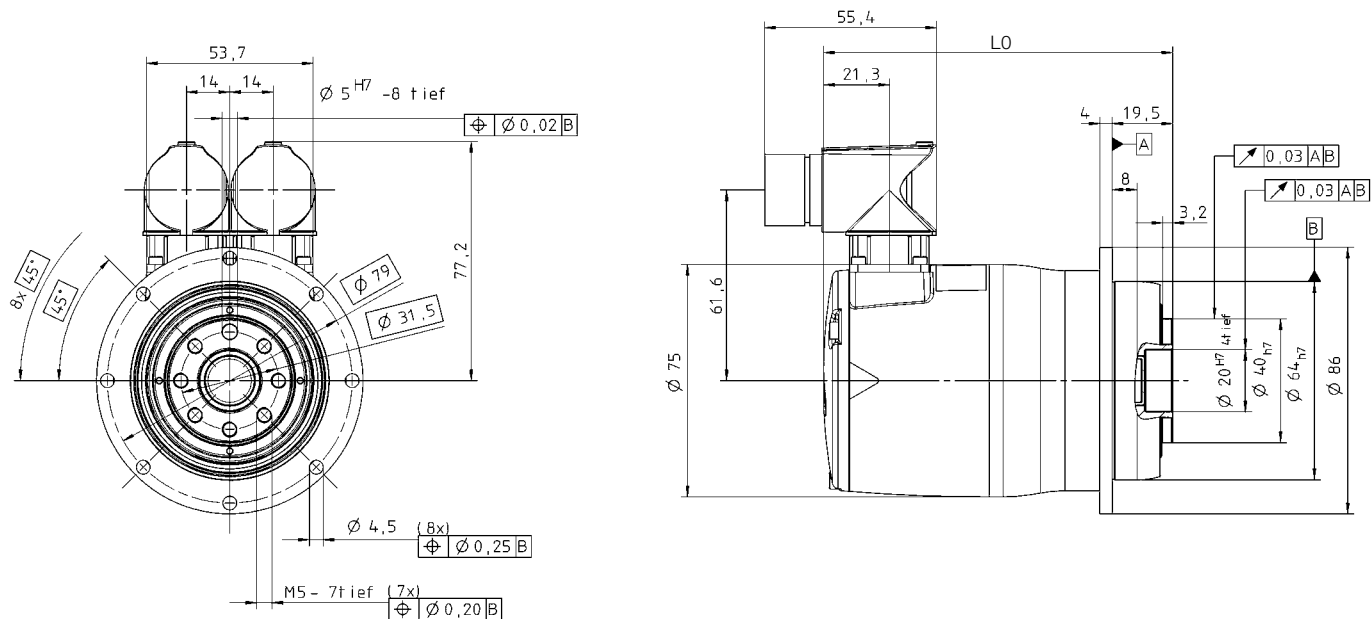

Electrical connection: Integral sockets, angled, manufactured by Intercontec, speedtec model, series A and B, size 1

Without brake

Ratio	Motor feedback	Length L0 in mm
i = 16/21/31	Resolver	128
i = 61/64/91	Resolver	113

With brake

Ratio	Motor feedback	Length L0 in mm
i = 16/21/31	Resolver	165
i = 61/64/91	Resolver	150

TPM+ dynamic

Size 010

Ratio	i		16	21	31	61	64	91
Motor size			64-30	64-30	64-30	64-15	64-15	64-15
Intermediate circuit voltage	U_D	V DC	48	48	48	48	48	48
Max. acceleration torque at output (max. 1000 cycles per hour)	T_{2B}	Nm	37,6	49,4	72,9	80	80	80
Static output torque	T_{20}	Nm	13,4	18,3	27,6	27,5	26,2	35
Brake holding torque at output, 100°C	T_{2BR}	Nm	17,6	23,1	34,1	67,1	70,4	100
Max. speed	n_{2max}	min ⁻¹	375	286	194	88,7	84,6	59,5
Speed limit for T2B	n_n	min ⁻¹	250	190	129	70,5	67,2	59,5
Max. motor acceleration torque	T_{mmax}	Nm	1,64	1,64	1,64	1,67	1,67	1,67
Max. motor acceleration current	I_{maxdyn}	A_{eff}	30	30	30	30	30	30
Motor stall current	I_0	A_{eff}	15	15	15	15	15	15
Mass moment of inertia (at motor shaft, without brake, with resolver)	J_1	kgm ² *10 ⁻⁴	0,32	0,32	0,32	0,17	0,17	0,17
Backlash	j_t	arcmin	Standard < 3 / Reduced < 1					
Torsional rigidity	C_t	Nm/ arcmin	/	26	24	24	/	21
Tilting rigidity	C_K	Nm/ arcmin	225					
Max. axial force	F_{amax}	N	2150					
Max. tilting torque (distance from point of rotation to output flange 57.6 mm)	M_{kmax}	Nm	270					
Weight (with resolver, without brake)	m	kg	4,8			4,3		
Operating noise (measured at motor speed of 3000 rpm)	L_{PA}	dB(A)	< 62					
Max. permitted housing temperature	ϑ_{max}	°C	90					
Ambient temperature	ϑ_U	°C	0 bis +40					
Protection class			IP65					
Mounting position			Any					
Lubrication			Synthetic oil, lubricated for life					
Insulating material class			F					
Paint			Metallic blue 250 and natural cast aluminum					

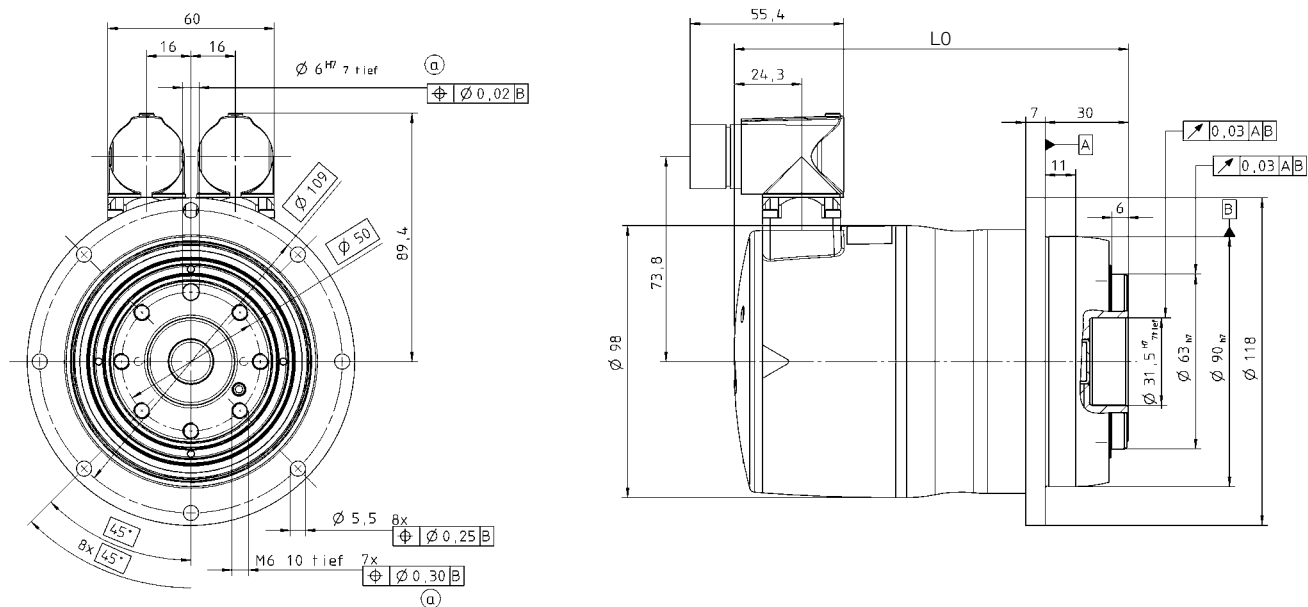

Electrical connection: Integral sockets, straight or angled, manufactured by Intercontec, speedtec model, series A and B, size 1

Without brake

Ratio	Motor feedback	Length L0 in mm
i = 16/21/31	Resolver	157
i = 61/64/91	Resolver	142

With brake

Ratio	Motor feedback	Length L0 in mm
i = 16/21/31	Resolver	178
i = 61/64/91	Resolver	163

TPM+ power

Size 004

Ratio	i		16	20	25	28	35	40	50	70	100	
Motor size			64-30	64-30	64-30	64-30	64-30	64-15	64-15	64-15	64-15	
Intermediate circuit voltage	U_D	V DC	48	48	48	48	48	48	48	48	48	
Max. acceleration torque at output (max. 1000 cycles per hour)	T_{2B}	Nm	38,2	47,7	50	50	50	50	50	50	35	
Static output torque	T_{20}	Nm	17,5	21,9	27,4	31,4	39,7	23,4	29,3	40	18	
Brake holding torque at output, 100°C	T_{2BR}	Nm	17,6	22	27,5	30,8	38,5	44	55	77	110	
Max. speed	n_{2max}	min ⁻¹	375	300	240	214	171	135	108	77,3	54,1	
Speed limit for T2B	n_{2n}	min ⁻¹	275	220	176	157	126	107	86	61,4	49,3	
Max. motor acceleration torque	T_{mmax}	Nm	1,64	1,64	1,64	1,64	1,64	1,67	1,67	1,67	1,67	
Max. motor acceleration current	I_{maxdyn}	A_{eff}	30	30	30	30	30	30	30	30	30	
Motor stall current	I_0	A_{eff}	15	15	15	15	15	15	15	15	15	
Mass moment of inertia (at motor shaft, without brake, with resolver)	J_1	kgm ² *10 ⁻⁴	0,32	0,31	0,31	0,31	0,31	0,16	0,16	0,16	0,16	
Backlash	j_t	arcmin	Standard < 4 / Reduced < 2									
Torsional rigidity	C_t	Nm/ arcmin	12	12	12	12	12	11	12	11	8	
Tilting rigidity	C_K	Nm/ arcmin	/									
Max. axial force	F_{amax}	N	1630									
Max. tilting torque (distance from point of rotation to out- put flange 57.6 mm)	M_{kmax}	Nm	110									
Weight (with resolver, without brake)	m	kg	3,7					3,3				
Operating noise (measured at motor speed of 3000 rpm)	L_{PA}	dB(A)	< 58									
Max. permitted housing temperature	ϑ_{max}	°C	90									
Ambient temperature	ϑ_U	°C	0 bis +40									
Protection class			IP65									
Mounting position			Any									
Lubrication			Synthetic oil, lubricated for life									
Insulating material class			F									
Paint			Metallic blue 250 and natural cast aluminum									

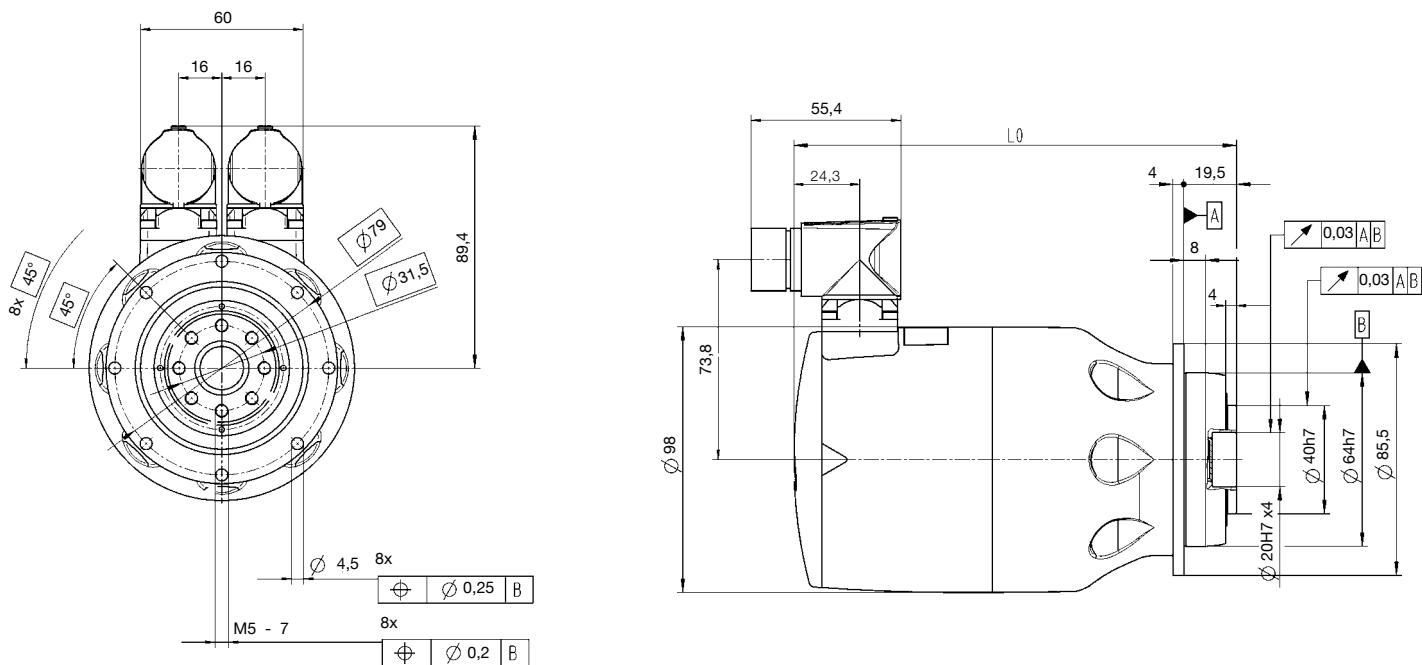

Electrical connection: Integral sockets, straight or angled, manufactured by Intercontec, speedtec model, series A and B, size 1

Without brake

Ratio	Motor feedback	Length L0 in mm
i = 16, 20, 25, 28, 35	Resolver	164
i = 40, 50, 70, 100	Resolver	149

With brake

Ratio	Motor feedback	Length L0 in mm
i = 16, 20, 25, 28, 35	Resolver	184
i = 40, 50, 70, 100	Resolver	169

Cables

Overview

Pre-configured lengths

The following pre-configured cables are available for fast commissioning of your drive system:

- Cables for [voltage supply](#) of the cyber® simco® line
 - [Fieldbus cables](#) for CANopen, EtherCAT, PROFINET, Sercos III and EtherNet/IP communication
 - Cables for [commissioning](#)
 - [Motor connection cables](#) for connecting to the servo drive.
- Further cable lengths are available upon request.



Motor connection cables

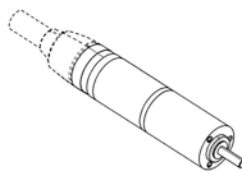
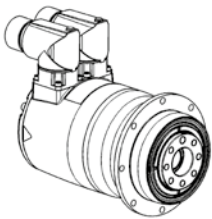
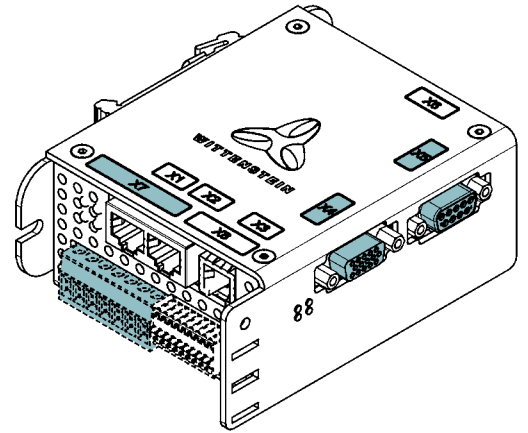
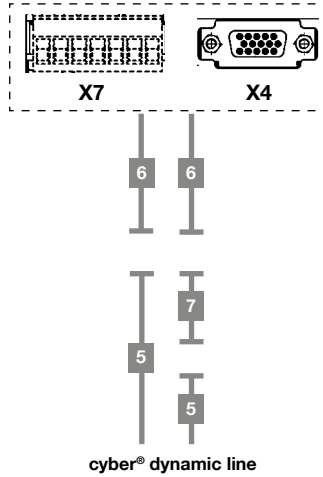
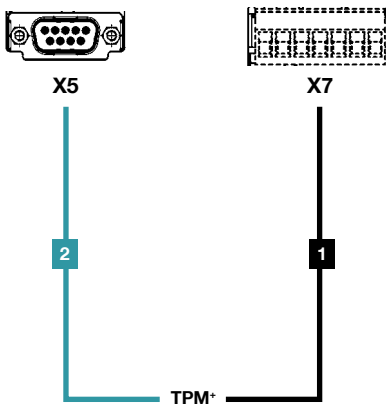

No.	Cable type	Description	Interfaces		Standard lengths / m
			Motor	Servo drive	
TPM+ Size 004 and 010					
1	Power cable	CAPOWE_U-SIM_4C_-D0150-S-LXXXX	speedtec Serie 923	Connector Phoenix Contact	0,5; 1; 2; 2,5; 3; 5
2	Signal cable resolver	CAB-SIG-R-SIM_C-D0000-S-LXXXX	speedtec Serie 923	Sub-D connector 9-pole	
3	Power cable	CAPOWE_U-SIM__F-D0075-S-LXXXX	speedtec Serie 923	itec series 915	
4	Signal cable resolver	CASIGN_R-SIM__F-D0000-S-LXXXX	speedtec Serie 923	M12 connector 8-pole	
cyber® dynamic line					
5	Motor connection cable	S/L-Kabel XXXHI-XXXX-BMS0-x/3	Direct cable outlet	itec, series 915	0,5; 3
6	Adapter cable for IP20	S/L-Kabel XXXHI-XXXX-BAS0-6/3	itec, series 915	Sub-D connector, 15-pin	0,5; 3; 5; 10; 15; 20
7	Extension cable	S/L-Kabel XXXHI-XXXX-BVS0-11/3	itec, series 915	itec, series 915	

Overview of motor connection options

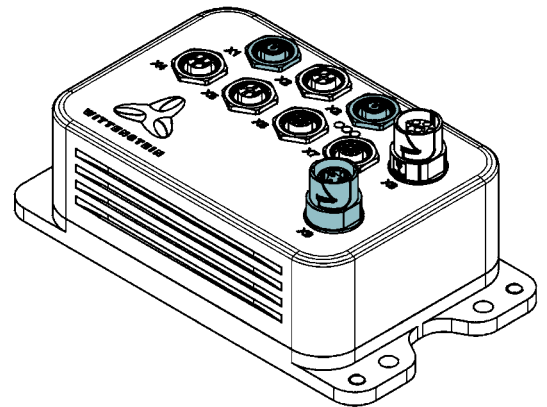
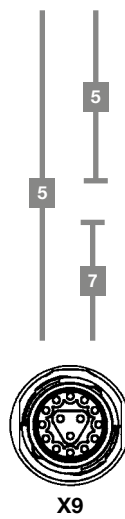
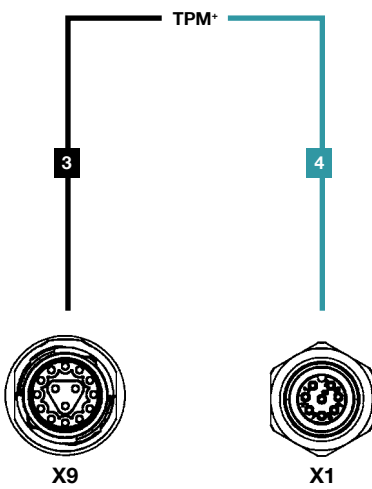

cyber® dynamic line



-  Power cable
-  Signal cable
-  Hybrid motor cable

Cables

TPM⁺

Technical details:

	Power cable (No. 1)	Power cable (No. 3)	Signal cable (No. 2, 4)
Drag chain suitable	max. 11 Mio. cycles		
Approval	UL (AWM-Style 20233/20234), CSA; CE		UL (AWM-Style 20233/20236), CSA; CE
Outer material	PUR		
Shielding	Yes		
Temperature range (static)	-40...+80°C		
Temperature range (dynamic)	-30...+80°C		
Min. bending radius (static)	4 × Outer-Ø		6 × Outer-Ø
Min. bending radius (dynamic)	7,5 × Outer-Ø		10 × Outer-Ø
Outer diameter	12,2 mm ± 0,3 mm	10,4 mm ± 0,3 mm	6,6 mm

Power cable for simco® IP20 (No. 1)

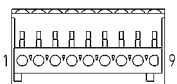
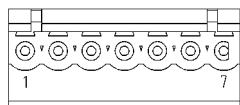
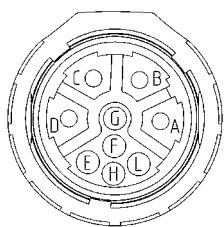

	speedtec series 923 Pin assignment (motor side)	Phoenix Contact Pin assignment (drive side)
Mot.Ph. U	A	3
Mot.Ph. V	B	4
Mot.Ph. W	C	5
PE	D	-
Br+	F	5
Br-	G	6
Temp Sens +	E	7
Temp Sens -	H	9
n.c.	L	-

Power cable for simco® IP65 (No. 3)

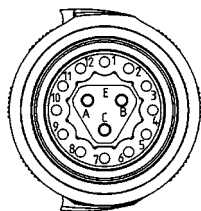
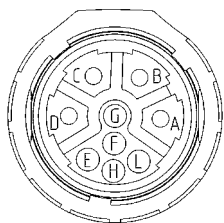

	speedtec series 923 Pin assignment (motor side)	itec series 915 Pin assignment (drive side)
Mot.Ph. U	A	A
Mot.Ph. V	B	B
Mot.Ph. W	C	C
PE	D	-
Br+	F	11
Br-	G	12
Temp Sens +	E	9
Temp Sens -	H	10
n.c.	L	-

Signal cable for simco® IP20 (No. 2)

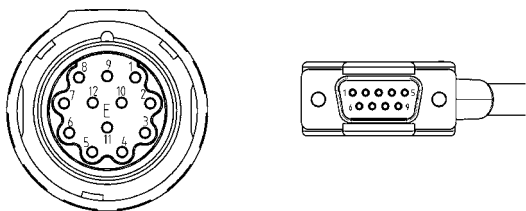

	speedtec series 923 Pin assignment (motor side)	Sub-D, 9-pin Pin assignment (drive side)
S1/cos	1	1
S1/cos -low	2	2
S2/sin	3	3
S4/sin-low	4	4
R1/Ref	7	5
R2/Ref-low	8	6

Signal cable for simco® IP65 (No. 4)

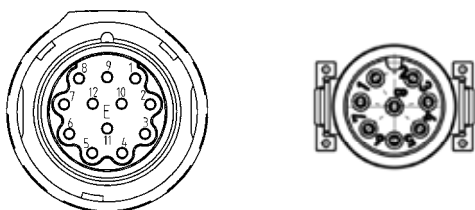

	speedtec series 923 Pin assignment (motor side)	M12 connector, 8-pin Pin assignment (drive side)
S1/cos	1	1
S1/cos -low	2	2
S2/sin	3	3
S4/sin-low	4	4
R1/Ref	7	5
R2/Ref-low	8	6

Cables

cyber[®] dynamic line

Technical details:

- Outer material: PUR
- Min. bending radius (static): $\geq 3xD$
- Min. bending radius (dynamic): $\geq 10xD$
- Temperature range: -20 bis 80°C
- Approval: UL AWM Style 20233, 80°C, 300V
- 2-fold screened
- Drag chain suitable (1.000.000 cycles)

Motor connection cable (No. 5)

Encoder: HI

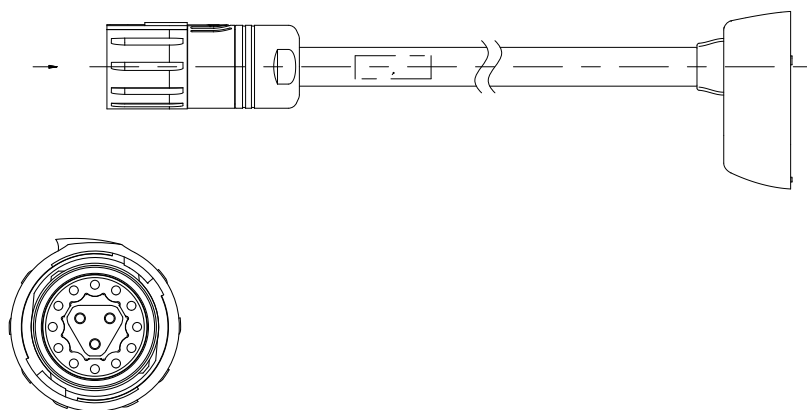

	Pin assignment
Mot.Ph. U	A
Mot.Ph. V	B
Mot.Ph. W	C
GND	1
5V	2
MA+ / Clock+	3
MA- / Clock-	4
SLO+ / Data+	5
SLO- / Data-	6

Motor size	Outer diameter in mm
17	7,2
22	7,6
32	8,7
40	8,7

Encoder: HF

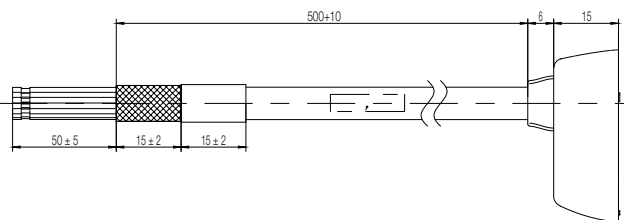

Motor size	Outer diameter in mm
17	8,5
22	8,8
32	9,7
40	9,7

	Color assignment	Shield
Mot.Ph. U	Red	Outer screen
Mot.Ph. V	White	
Mot.Ph. W	Black	
Hall A	Brown	
Hall B	Orange	
Hall C	Yellow	
GND	Blue	Inner screen
5V	Red	
A+	Pink	
A-	Green	
B+	Grey	
B-	Yellow	
Z+	White	
Z-	Brown	

Adapter cable for simco® IP20 (No. 6)

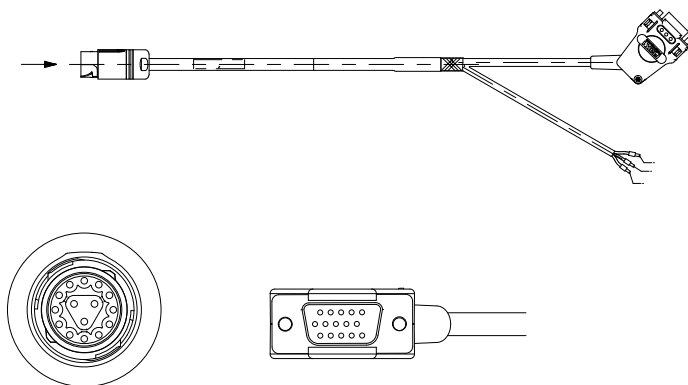

	Pin assignment (motorseitig)	Pin-/Color assignment (servo drive)
Mot.Ph. U	A	Red
Mot.Ph. V	B	White
Mot.Ph. W	C	Black
GND	1	1
5V	2	2
MA+ / Clock+	3	3
MA- / Clock-	4	4
SLO+ / Data+	5	5
SLO- / Data-	6	6

Outer diameter: 8,7 mm

Extension cable (No. 7)

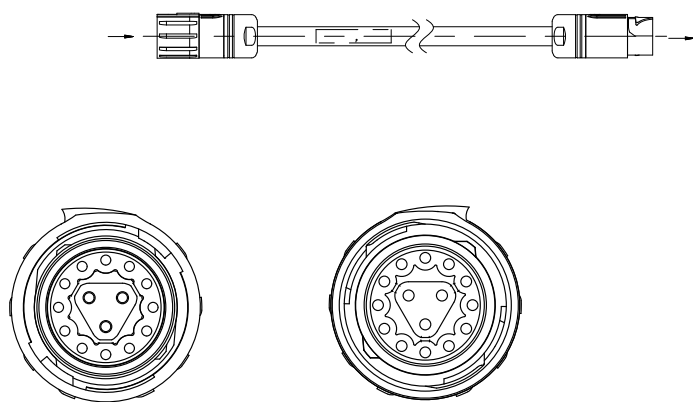

	Pin assignment
Mot.Ph. U	A
Mot.Ph. V	B
Mot.Ph. W	C
Hall A	9
Hall B	10
Hall C	11
GND	1
5V	2
MA+ / Clock+ / A+	3
MA- / Clock- / A-	4
SLO+ / Data+ / B+	5
SLO- / Data- / B-	6
Z+	7
Z-	8

Outer diameter: 9,7 mm

Cables

cyber® simco® line

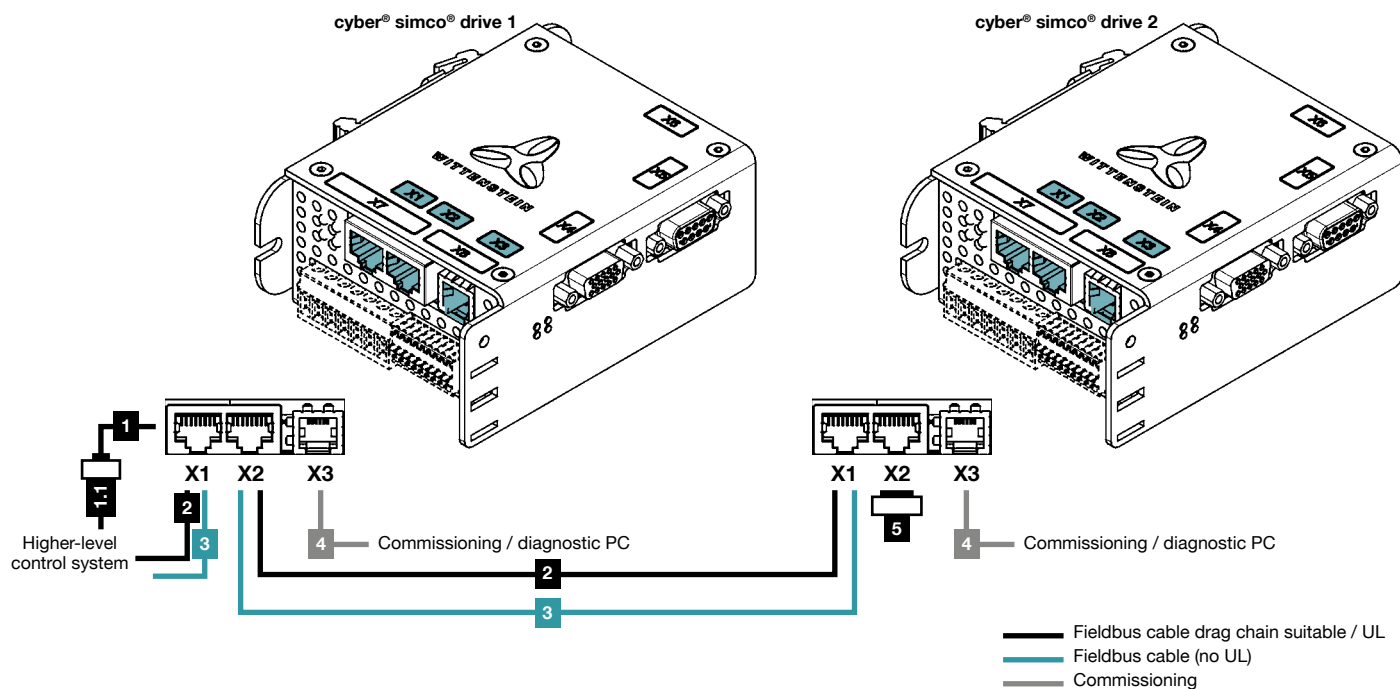

SIM2002D, SIM2010D, SIM2015D und SIM2050D IP20

No.	Type of accessory	Description	Interfaces		Description	Standard lengths
			simco® drive 1	PLC / PC / simco® drive 2		
Fieldbus cabinet / drag chain suitable (UL)						
1	Fieldbus cable controller	CAB-BUS-CAN-RJ45-FL-LXXXX	RJ45 connector	Flying leads	Fieldbus connection to PLC; for fieldattachable connectors	1,5; 5 m
1.1	CANopen Sub-D connector	SUBCON-PLUS-CAN/PG	-	-	9-pin connector with cable entry and outlet as well as switchable terminating resistor	-
2	Fieldbus cable controller / simcos	CAB-BUS-UN2-RJ45-RJ45-LXXXX	RJ45 connector	RJ45 connector	Fieldbus connection to PLC / second simco drive	0,3; 1; 2; 3 m
Fieldbus cabinet (no UL)						
3	Fieldbus cable controller / simcos	CAB-BUS-UN1-RJ45-RJ45-LXXXX	RJ45 connector	RJ45 connector	Fieldbus connection to PLC / second simco® drive	0,3; 1; 2; 3 m
Commissioning						
4	RS232 connection cable	CAB-BUS-RS_-RJ12-SF09-L0300	RJ12 connector	Sub-D connector	Connection cable for diagnostic purposes, commissioning with MotionGUI	3 m
Other						
5	CANopen terminating resistor	CAB-BUS-CAN-RJ45-TERMINAT	-	RJ45 connector	Only necessary for CAN communication	-

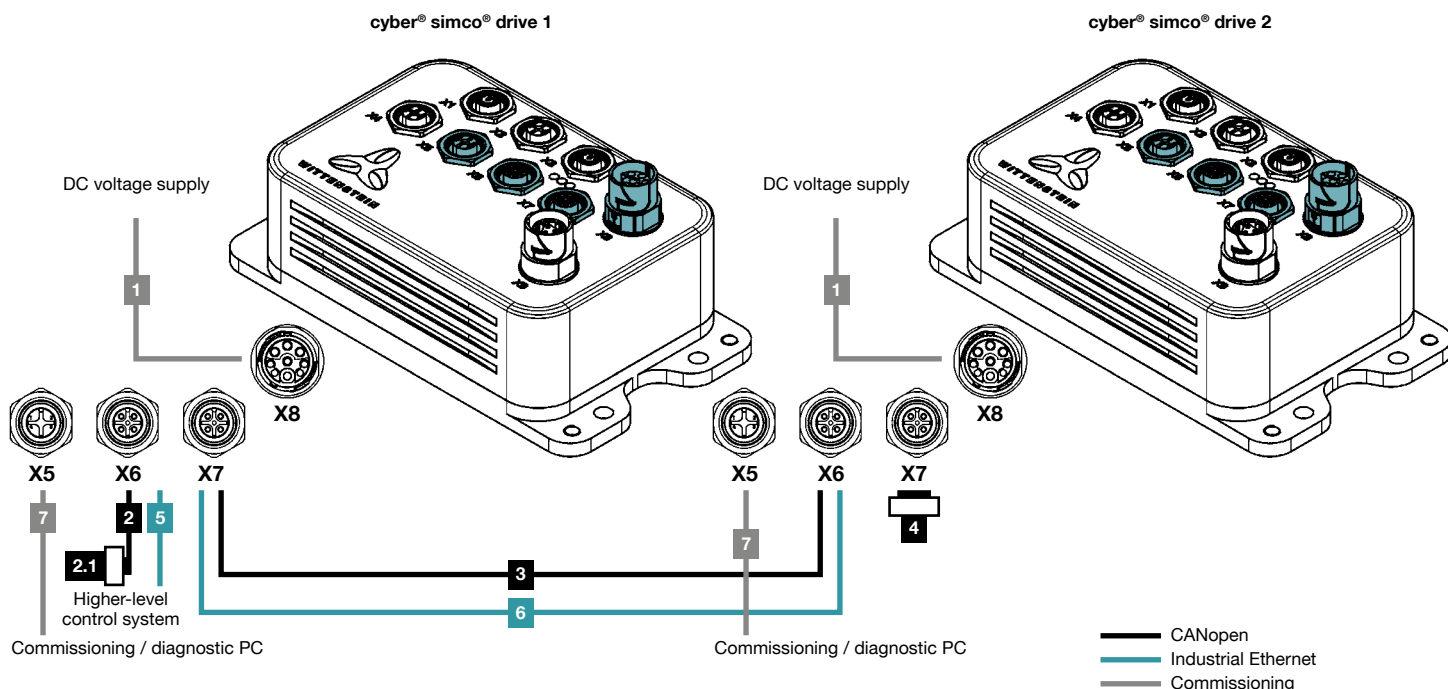

SIM2002D und SIM2010D IP65

No.	Type of accessory	Description	Interfaces		Description	Standard lengths
			simco® drive 1	PLC / PC / simco® drive 2		
Voltage supply						
1	Voltage supply	CAB-SUP-SIM2010D-F-D0075-LXXXX	ltec series 915	Flying leads	DC voltage supply cable	2; 5; 10 m
Fieldbus CANopen						
2	Fieldbus cable controller	CAB-BUS-CAN-M12M-FL_-LXXXX	M12 connector, 5-pin, A-coded	Flying leads	Fieldbus connection to PLC; for fieldattachable connectors	5 m
2.1	CANopen Sub-D connector	SUBCON-PLUS-CANopen/PG	-	-	9-pin connector with cable entry and outlet as well as switchable terminating resistor	-
3	Fieldbus cable simcos	CAB-BUS-CAN-M12M-M12M-LXXXX	M12 connector, 5-pin, A-coded	M12 connector, 5-pin, A-coded	Fieldbus connection between simco® drives	0,5 m; 1 m
4	CANopen terminating resistor	CAB-BUS-CAN-M12M-TERMINAT	-	M12 connector, 5-pin, A-coded	Only necessary for CAN communication	-
Industrial Ethernet (EtherCAT / PROFINET / EtherNet/IP / SERCOS III)						
5	Network cable controller	TCC 002-025-XXXX-PUR	M12 connector, 4-pole, D-coded	RJ45 connector	Network connection to PLC	1; 2; 5; 10; 15 m
6	Network cable simcos	TCC 002-026-XXXX-PUR	M12 connector, 4-pole, D-coded	M12 connector, 4-pole, D-coded	Network connection between simco® drives	1; 2; 5; 10; 15 m
Inbetriebnahme						
7	RS232 connection cable	CAB-BUS-RS_-M12M-SF09-LXXXX	M12 connector, 4-pole	Sub-D connector	Connection cable for diagnostic purposes, commissioning with MotionGUI	5 m

Cables

cyber[®] simco[®] line

Technical details:

	Fieldbus cable IP20 (No. 1, 2) / IP65 (No. 5, 6)	Fieldbus cable IP20 (No. 3)	Voltage supply cable IP65 (No.1)	Fieldbus cable IP65 (No.2, 3)
Drag chain suitable	max. 3 Mio. cycles	No	No	max. 5 Mio. cycles
Approval	UL (AWM-Style 20233/11602), CSA; CE	CE	CE	UL (AWM-Style 20233/10578), CSA; CE
Outer material	PUR	FRNC	PVC	PUR
Shielding	Yes	Yes	No	No
Temperature range (static)	-40...+80°C	0...+50°C	-15...+70°C	-40...+80°C
Temperature range (dynamic)	-30...+70°C	-20...+60°C	-15...+70°C	-30...+70°C
Min. bending radius (static)	5 × Outer-Ø	7,5 × Outer-Ø	4 × Outer-Ø	6 × Outer-Ø
Min. bending radius (dynamic)	12 × Outer-Ø	10 × Outer-Ø	10 × Outer-Ø	10 × Outer-Ø
Outer diameter	6,7 mm ± 5 %	5 mm ± 5 %	9,1 mm ± 3 %	6,9 mm ± 5 %
Transmission parameter	CAT 5, Class D (ISO/IEC 11801:2002), (EN 50173-1)		-	-
Transmission rate	up to 100 Mbit/s Full Duplex		-	-

Fieldbus cable IP20 (No. 1)

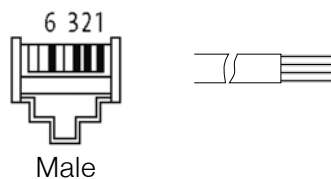

	RJ45 Con. straight Pin assignment	Flying leads Color assignment
TD+	1	Yellow
TD-	2	Orange
RD+	3	White
RD-	6	Blue

Fieldbus cable IP20 (No. 2 und 3)

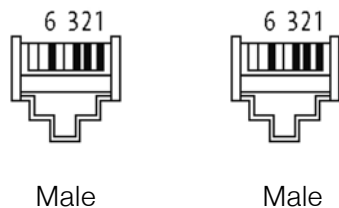

	RJ45 Con. straight Pin assignment	RJ45 Con. straight Pin assignment
TD+	1	1
TD-	2	2
RD+	3	3
RD-	6	6

Voltage supply cable IP65 (No. 1)

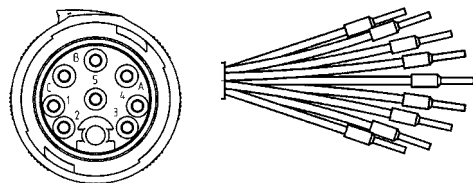

	Intercontec connector, 9-pole, Pin assignment	Flying leads Labeling
DCBUS	A	6
DCBUS	B	7
CHOPPER	C	8
PE	PE	PE
VCC24	1	1
GND	2	2
STO	3	3
NC	4	4
STO GND	5	5



Fieldbus cable CANopen IP65 (No. 2)

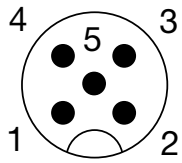

Male, A-coded

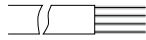

	M12 Con. straight Pin assignment	Flying leads Color assignment
Shield	1	-
+	2	Red
-	3	Black
CAN-H	4	White
CAN-L	5	Blue

Fieldbus cable CANopen IP65 (No. 3)

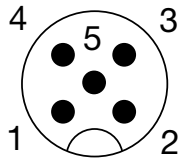

Male, A-coded

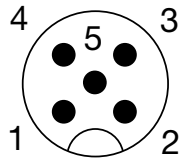

Male, A-coded

	M12 Con. straight Pin assignment	M12 Con. straight Pin assignment
Shield	1	1
+	2	2
-	3	3
CAN-H	4	4
CAN-L	5	5

Network cable Ethernet IP65 (No. 5)

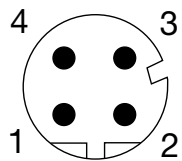

Male, D-coded



Male

	M12 Con. straight Pin assignment	RJ45 Con. straight Pin assignment
TD+	1	1
TD-	3	2
RD+	2	3
RD-	4	6

Network cable Ethernet IP65 (No. 6)

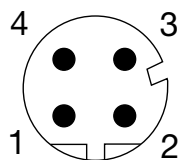

Male, D-coded

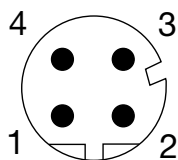

Male, D-coded

	M12 Con. straight Pin assignment	M12 Con. straight Pin assignment
TD+	1	1
TD-	3	3
RD+	2	2
RD-	4	4

Accessory

cyber[®] simco[®] line

SIM2050D heat sink kit

- Heat sink for the SIM2050 variant of the simco[®] drive
- Scope of supply: Heat sink with M4x14 screws for attachment to the drive
- Different mounting holes enable the heat sink to be turned
- Servo drive and heat sink can optionally be mounted using the four M4 threads (D-D) on the sink.

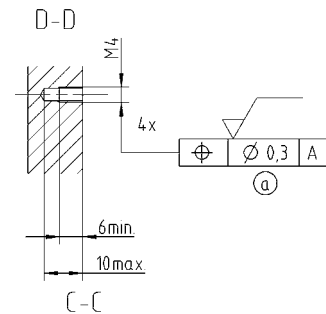
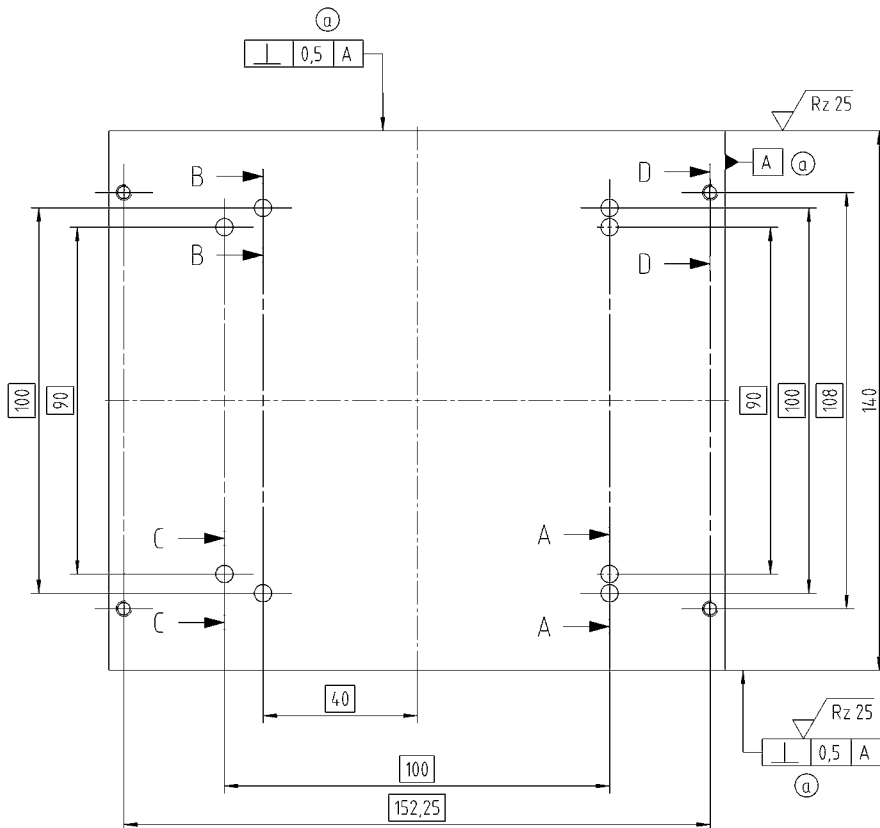
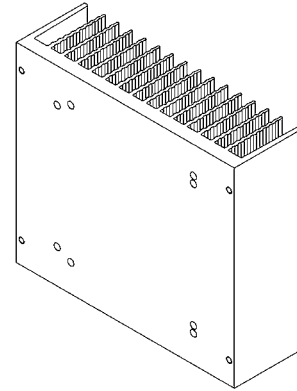
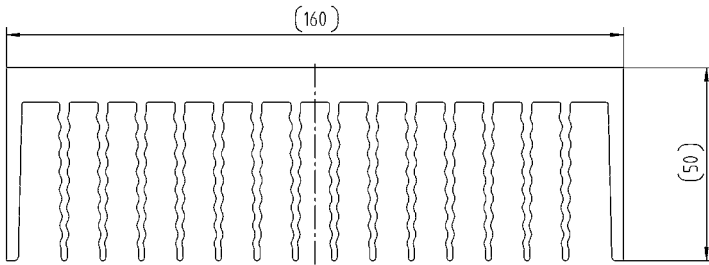

IP20 shield terminal for SIM2002 / 2010 / 2015

- Shield terminal for 3-12 mm shield diameter
 - Connection of the outer shielding of the motor cable through clamping area
 - Cable tie provides strain relief through the outer sheath
- If a servo drive in the cyber® simco® line is ordered as IP20 version with a shield terminal, it will be supplied with the shield terminal pre mounted

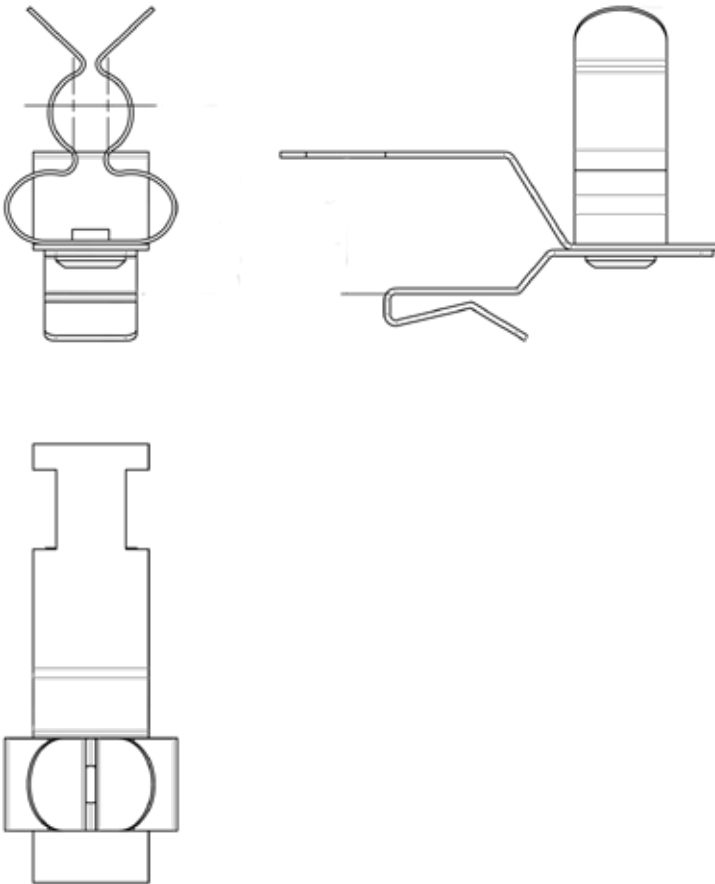

Order codes

cyber® simco® line

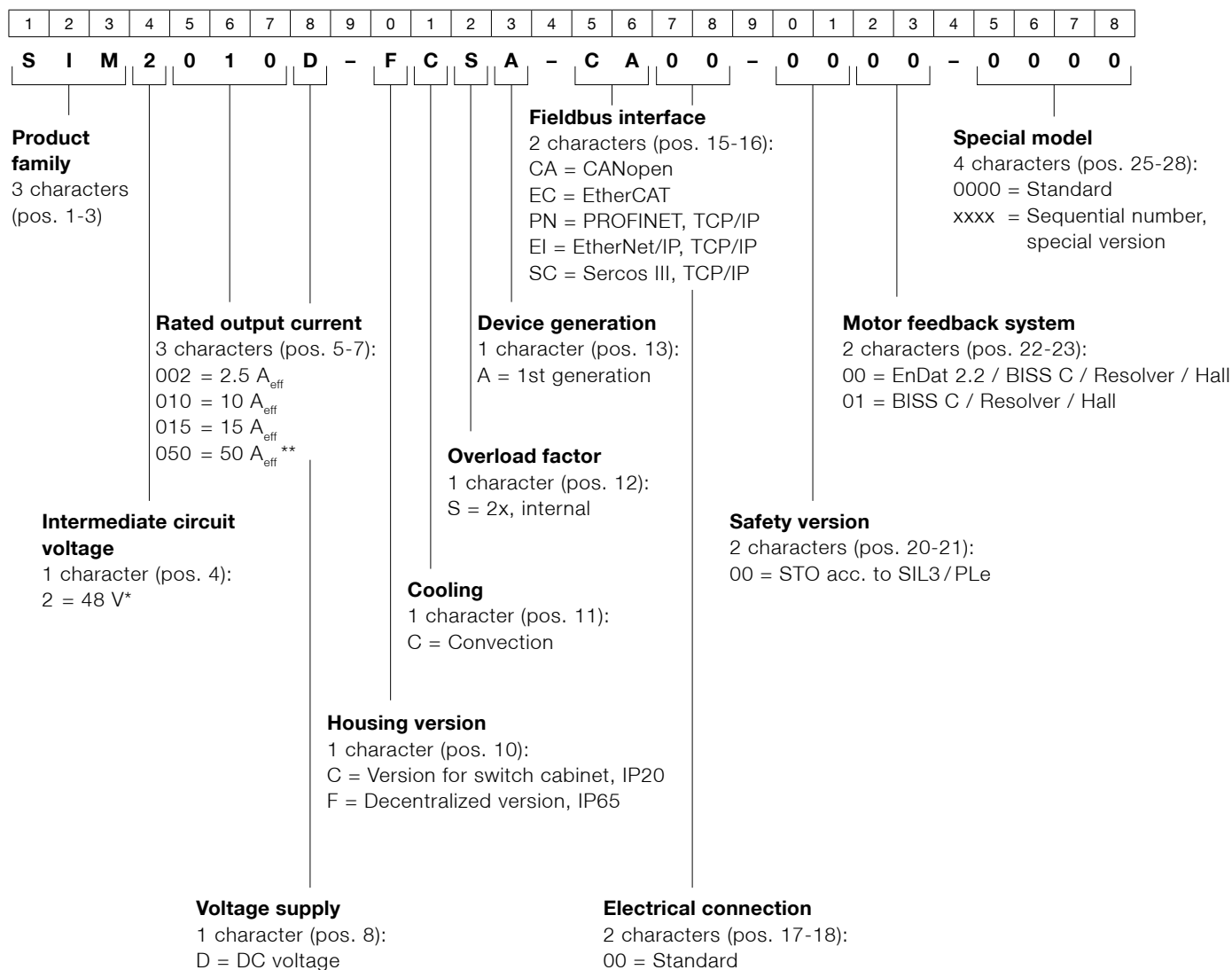

* according to the version 12 - 60 VDC (cf. p. 26)
** see cyber® simco® line performance data (cf. p. 26)

cyber® dynamic line

1	2	3	4	5	6	7	8	9	0	1	2	3	4	5	6	7	8	9	0	1	2	3	4	5	6	7	8	9	0
M	R	S	R	0	1	6	B	-	0	1	0	C	-	2	C	0	B	S	-	H	I	0	G	S	N	-	N	N	N

Design

1 character
(pos. 1)

M = Motor
A = Actuator

Mode of drive

1 character
(pos. 2)

L = Linear
R = Rotative

Frame size

(Outer diameter of
the stator lamination
in mm)

3 characters (pos. 5-7)

016 = Size 17

021 = Size 22

030 = Size 32

038 = Size 40

Length

(active length in mm)

3 characters (pos. 10-12)

Electrical connection

1 character (pos. 19)

S = plug connector on PCB

U = Inox Design (with gable
gland, with plug, defined
cable length)

F = Inox Design (with gable
gland, no plug, defined
cable length)

Application range

1 character (pos. 25)

S = Standard

L = Food industry (Hygienic
Design)

Stroke (at ALxx) or gear box ratio (at ARxx)

1 character (pos. 28)

Feedback system

2 characters (pos. 21-22)

HI = absolute BISS-Interface

HF = Incremental

Order codes

Motor connection cable cyber® dynamic line

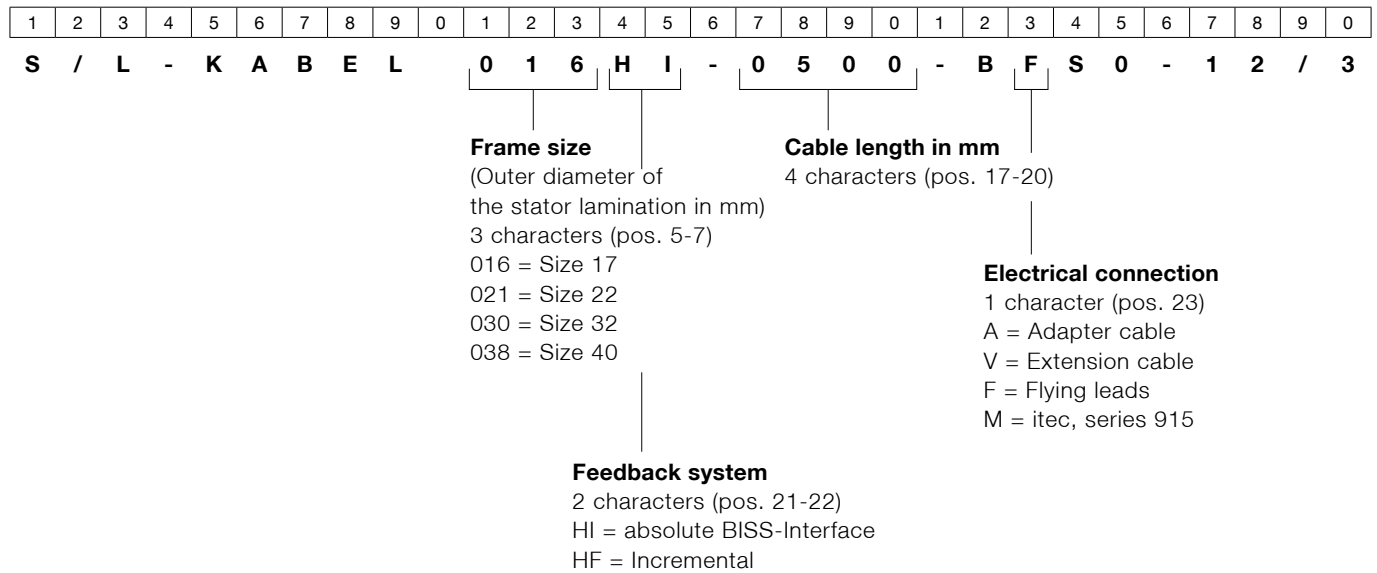

TPM+

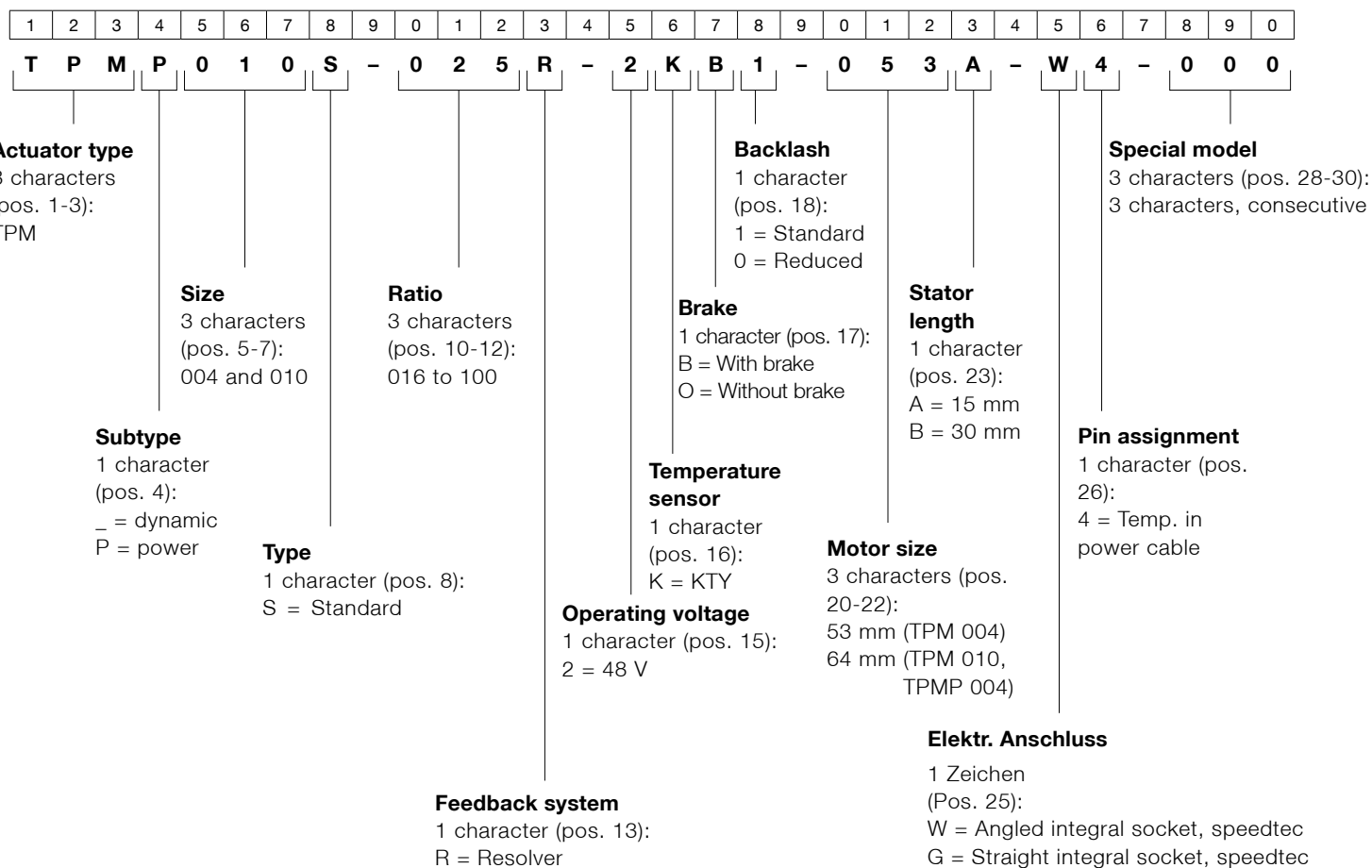

SERVICE CONCEPT



Our services at a glance

PRE-SALES		AFTER-SALES	
Planning	Investment	Application	Re-investment
Consultation & design Customer training Info & CAD Finder	cymex® sizing software Engineering Sensors cymex® statistics	Manuals Commissioning Pick-up & return service Repair service Preventive maintenance	Modernization service

Our **service concept** continues to raise the bar in service quality. We are there for you, from the initial concept and throughout the entire life cycle of your application.



Contact information

PRE-SALES

Support hotline

For reliable and expert dimensioning.

Tel.: +49 7931 493-15800
Fax: +49 7931 493-10905
Email: info@wittenstein-cyber-motor.de

AFTER-SALES

Service hotline

For fast and unbureaucratic assistance with repairs and questions about supplied products.

Tel.: +49 7931 493-15900
Fax: +49 7931 493-10903
Email: service@wittenstein-cyber-motor.de

Technical support

For any questions on installation, commissioning and optimization.

Tel.: +49 7931 493-14800
Email: wcm-support@wittenstein.de

For detailed information, please visit www.wittenstein-cyber-motor.de





cyber motor

WITTENSTEIN cyber motor GmbH · Walter-Wittenstein-Straße 1 · 97999 Igersheim · Germany
Tel. +49 7931 493-15800 · info@wittenstein-cyber-motor.de

WITTENSTEIN Inc. · 1249 Humbracht Circle · Bartlett, IL 60103 · USA
Tel. +1 630 540 5300 · info.cyber-motor@wittenstein-us.com

WITTENSTEIN S.P.A. · Via Giosuè Carducci 125 · 20099 Sesto San Giovanni MI · Italy
Tel. +39 02 241357-1 · info@wittenstein.it

WITTENSTEIN Co., Ltd. · 2-6-6 Shibadaimon Minato-ku · 105-0012 Tokyo · Japan
Tel. +81 3 6680 2835 · sales@wittenstein.jp

WITTENSTEIN (Hangzhou) Co., Ltd. · No. 355 Tianmushan West Road · 311122 Hangzhou · China
Tel. +86 571 8869 5852 / 5851 · info@wittenstein.cn



WITTENSTEIN – one with the future

www.wittenstein-cyber-motor.de